

ALESIS

DM8

HIGH-DEFINITION DRUM MODULE
WITH DYNAMIC ARTICULATION

OPERATOR'S MANUAL

TABLE OF CONTENTS

INTRODUCTION	3
GETTING STARTED	4
RESETTING THE MODULE TO FACTORY DEFAULTS	4
CHECK FOR UPDATES	4
CALIBRATE YOUR HI-HAT PEDAL.....	4
DEACTIVATE WRITE PROTECTION	4
THE BASICS	5
NAVIGATING MENUS & ADJUSTING SETTINGS	5
KITS	5
VOICES: LAYERS & INSTRUMENTS	6
VOLUME	6
SEQUENCES	6
STORING DATA	7
UTILITY	7
REAR PANEL FEATURES	8
TOP PANEL FEATURES	8
KITS, VOICES, ACCOMPANIMENT & INSTRUMENTS	10
SELECTING A KIT	10
EDITING INSTRUMENTS IN A KIT	10
EDITING ACCOMPANIMENT IN A KIT	11
EDITING VOICE & ACCOMPANIMENT PARAMETERS.....	12
EDITING MIDI PARAMETERS.....	14
EDITING EFFECTS PARAMETERS	15
DRUM KIT SETUP	18
SEQUENCES	19
PLAYING SEQUENCES	19
RECORDING SEQUENCES	20
EDITING SEQUENCES (DRUMS)	20
EDITING SEQUENCES (ACCOMPANIMENT).....	21
SETTING UP THE CLICK TRACK	22
EDITING QUANTIZATION SETTINGS.....	23
STORING & COPYING DATA	24
NAMING	24
STORING & COPYING KITS	24
COPYING INSTRUMENTS	25
STORING SEQUENCES.....	25
STORING TRIGGER SETTINGS	25
EXT. TRIG MENU	26
TRIGGER INPUT PARAMETERS	26
TRIGGERING PARAMETERS	27
VELOCITY CURVE	28
MODE (RIDE BOW & BELL)	28
HI-HAT CALIBRATION.....	29
STORING EXT. TRIG SETTINGS.....	29
EXPLORING OPTIMAL SENSITIVITY AND THRESHOLD SETTINGS	29
UTILITY MENU	30
GENERAL	30
METRONOME (F1)	30
MIDI (F2)	32
TRIG (F3)	33
SYS (F4)	33
UPDATING THE MODULE	34
MIDI SETUP	35
RESTORING BACKUP SYSEX FILES	36
MIDI IMPLEMENTATION CHART	37
DM8 KITS	38
DM8 SEQUENCES	39
DM8 INSTRUMENTS	40

INTRODUCTION

Welcome to the Alesis DM8 drum module! The DM8 includes lots of high-fidelity drum, percussion, and accompaniment sounds giving you the sonic realism of acoustic drums but with the convenience and flexibility of electronic drums.

This manual details all the DM8 module's features. If you want to learn fast so you can dive right into playing, refer to the included Quickstart Guide. Or, for a brief overview of the module's features, see the BASICS chapter. Of course, we also recommend reading through this manual so you can take full advantage of all the amazing functions of the DM8.

Happy drumming!

The Alesis Team

CONNECTION DIAGRAM

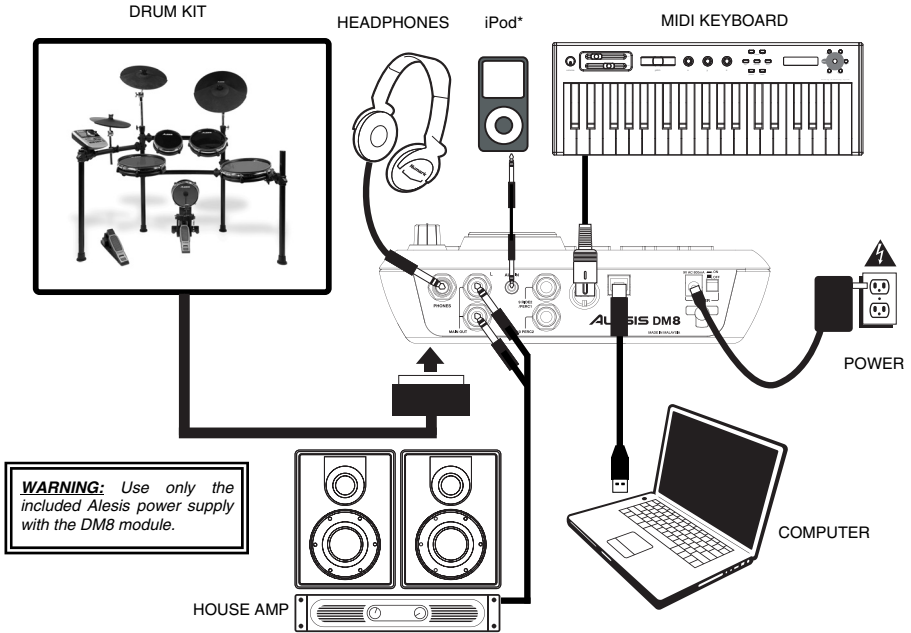

Headphones, iPod, keyboard, amp, and computer not included.
* iTunes and iPod are trademarks of Apple, Inc., registered in the U.S.A. and other countries.*

- Connect the 1/4" cables of your kit's cable snake to the drum pads and cymbal pads of your kit. Each cable is labeled with its proper trigger.
- If you have additional drum pads, cymbal pads, or other triggers, you can use standard 1/4" cables to connect them to the "RIDE 2/PERC1" or "PERC2" TRIGGER INPUTS on the module's rear panel. Dual-zone pads or cymbals (e.g., a drum with head and rim triggers or a cymbal that can produce bow and bell sounds) will require TRS cables to trigger both zones.
- Plug 1/4" TRS cables from the MAIN OUT to an amplifier, mixer, or speaker system. (For mono sound, connect a cable to the Left output.)
- You can connect a set of 1/4" TRS headphones to the PHONES output.
- You can connect another audio device to the AUX IN using a standard 1/8" stereo cable.

Refer to your electronic drum kit's assembly manual for more information on connecting it to the DM8 module.

IMPORTANT:

- Always turn down your volume level(s) to zero before plugging or unplugging your cables from your triggers or the module.
- The DM8 module may be affected by static electricity. If this occurs, simply turn the module off and wait at least a few seconds before turning it on again.

GETTING STARTED

Please read the following instructions to set up your DM8 module for its first use!

RESETTING THE MODULE TO FACTORY DEFAULTS

If you ever need to return the module to its original default factory settings, press and hold the EXIT and STORE buttons simultaneously while turning it on.

CHECK FOR UPDATES

Since the initial release of this module, we may have released new firmware or sound ROM files. To ensure your DM8 module has the latest sounds and software features, we recommend checking the "Docs & Downloads" tab of www.alesis.com/dm8 for available updates. See the UPDATING THE MODULE chapter for more information.

CALIBRATE YOUR HI-HAT PEDAL

The first time you connect a hi-hat pedal to the DM8 module, we recommend calibrating it so the module can "read" the pedal's movement optimally. If you use the same hi-hat each session (even if you have disconnected and reconnected it), then you shouldn't need to calibrate each time as long as you store your trigger settings after calibrating (see STORING TRIGGER SETTINGS in the STORING & COPYING chapter for more information). However, anytime you connect a different hi-hat from the previously connected one, you should calibrate it.

Note: The module's HI-HAT CONTROL TRIGGER INPUT does not support keyboard-style expression pedals.

To calibrate the hi-hat pedal:

1. Connect the hi-hat pedal to the module but do not press it down.
2. On the module, press EXT TRIG.
3. Use the CURSOR UP / DOWN buttons to highlight the "Input" field at the top of the screen then use the VALUE UP / DOWN buttons or VALUE DIAL to select "HiHat."
4. Press CAL (F1).
5. With the hi-hat pedal completely raised ("open"), press OPEN (F1) and wait for a message saying the process is complete.
6. With the hi-hat pedal completely pressed ("closed"), press CLOS (F2) and wait for a message saying the process is complete.
7. If you want to fine-tune how the module detects your pedal's "open" and "closed" positions, press TRIM (F3). Use the CURSOR UP / DOWN buttons to select "Open" or "Closed" and use the VALUE UP / DOWN buttons or VALUE DIAL to adjust the setting. (**Tip:** Increasing the "Closed" value makes it easier to close the hi-hat or "choke" it.)
8. If you want to adjust the response curve of the pedal, press CURV (F4). Use the VALUE UP / DOWN buttons or VALUE DIAL to select the curve that best suits your playing style. (**Tip:** We recommend using LINEAR, LOG1 or LOG2 for conventional hi-hat performance.)
9. When you have adjusted the hi-hat settings to your preference, press EXIT to exit the calibration page (or press DRUM KIT to return to the main screen).

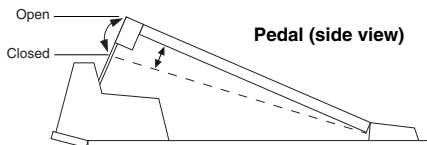
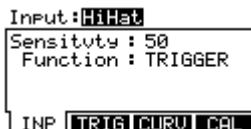

DEACTIVATE WRITE PROTECTION

Out of the box, the DM8 module is write-protected, so you will be unable to save any changes you make to the Kits, Instruments, Sequences, etc.

To turn write protection off:

1. Press UTILITY.
2. Press SYS (F4).
3. Press O/S (F3).
4. Press MEM (F4).
5. Press VALUE DOWN or move the VALUE DIAL counterclockwise until the "WriteProt" field says "OFF."
6. Press DRUM KIT to return to the main page.

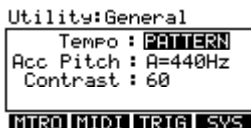

THE BASICS

This section of the manual outlines the basic features and concepts of the DM8. Each section below refers to another part of this manual that will explain the features in greater depth.

NAVIGATING MENUS & ADJUSTING SETTINGS

We designed the DM8's user interface to be as simple and as easy to use as possible.

- **DRUM KIT** – Press this button to select the Main Screen, where you can select the current Kit. (From this page, you can press CURSOR DOWN to enter the Drum Kit Setup Menu, where you can adjust the overall Kit volume level, MIDI Program Change settings, or restore the current Kit's factory settings.)
- **SEQ** – Press this button to enter the sequencer, where you can select a Sequence to play and adjust overall settings for the module's sequencer.
- **EDIT INST** or **EDIT ACCOMP** – Press one of these buttons to reassign the sound for a trigger or to edit the sound of the Accompaniment track. You can also adjust other settings such as effects, velocity-related parameters, MIDI settings, and more.
- **EXT TRIG** – Press this button to adjust sensitivity, crosstalk, thresholds, velocity curves, and other settings for the triggers.
- **UTILITY** – Press this button to enter the Utility Menu, where you can adjust metronome and MIDI settings, update or reset the module, and more.

You can navigate the menus and adjust settings and parameters shown on the module's LCD with the following controls:

- **F-BUTTONS** – Pressing the F1, F2, F3, and F4 buttons will select whatever "tab" is displayed above it on the LCD.
- **CURSOR UP / DOWN** – Press either of these buttons to move up or down through the menu on the screen. (Pressing the CURSOR DOWN button while on the Main Screen will call up the Kit Setup screen where you can adjust the volume and MIDI settings of the current Kit.)
- **VALUE DIAL** – Turn the wheel clockwise or counterclockwise to adjust the selected menu item (usually highlighted). This allows for quick adjustment of settings and parameters – the faster you turn the wheel, the faster it will scroll through the options.
- **VALUE UP / DOWN** – Press the VALUE UP or VALUE DOWN buttons to adjust the selected menu item (usually highlighted) one increment at a time. These buttons are better for more precise adjustment of settings than the VALUE DIAL.
- **EXIT** – Press this to return to the previous menu.

See the TOP PANEL FEATURES chapter for more information about these and other controls.

KITS

The DM8 module includes 100 Preset Kits and 100 empty User Kits. A Kit is a set of sounds that you can select in the module that will be triggered by your drums when you play them. The Preset Kits come pre-programmed so you can start playing with premium sounds right away. The empty User Kits are for you to create your own by assigning individual sounds to each trigger in the Kit. Furthermore, you can save over 100 Preset Kits in user memory, allowing for even more creative space. (The defaults can be easily restored by reinitializing the module).

To select a Kit, simply press DRUM KIT to enter the Main Screen, then use the VALUE UP / DOWN buttons or VALUE DIAL to select a new Kit number.

For more information on selecting and editing Kits, see the KITS, VOICES, ACCOMPANIMENT & INSTRUMENTS chapter.

Important: At any given time, the DM8 module has a Kit selected and a Sequence selected. If you change the Sequence, this will change your current Kit to the one that is associated with that Sequence. If you change the Kit, this will NOT change the current Sequence. However, if you then play the current Sequence, the chords or "hit groups" may sound unusual. In this case, we recommend muting Layer B of that Kit's Accompaniment (see EDITING VOICE & ACCOMPANIMENT PARAMETERS for more information) or muting the Accompaniment altogether by pressing MUTE ACCOMP.

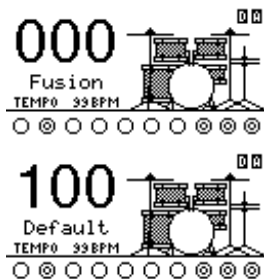

VOICES: LAYERS & INSTRUMENTS

Whenever you strike a trigger on your electronic drum set (e.g., a cymbal, a drum pad, etc.), it will trigger a Voice in the module. A Voice is the sound assigned to that trigger. Each Voice consists of two Layers, and each Layer has its own Instrument (a drum sound such as a tom, snare, hi-hat, etc.) which can be selected or edited.

We created the dual-layer feature in the DM8 so you can play with more powerful composite and layered sounds and timbres using your electronic drum kit. You can make subtle or dramatic changes to the sound of your Kits by changing the Instruments in each Layer. Furthermore, you can adjust certain parameters of the drum Voices (e.g., tuning, velocity, reverb, panning, etc.) in the module.

For more information on selecting and editing Voices, see the KITS, VOICES, ACCOMPANIMENT & INSTRUMENTS chapter.



VOLUME

You may have noticed that there are several ways to adjust the volume of your performance when using the DM8. You can:

- **Adjust the levels of the Voices in the Kit:** Press DRUM KIT to enter the main screen then EDIT INST. Select the Voice to edit (top of the LCD) with the VALUE UP / DOWN buttons or VALUE DIAL (or by striking the trigger with NOTE CHASE on). Press LVL (F2) to enter the Level page. (Remember that each Voice has two Layers, A and B, which you can toggle between by pressing the EDIT INST button.)
- **Adjust the level of the entire Kit:** Press DRUM KIT to enter the main screen then CURSOR DOWN to enter the Drum Kit Setup Menu, where you can set the overall Kit level.



Please note the module's trigger sensitivity, threshold, velocity curve settings can also affect the dynamics of your performance. See the EXT. TRIG MENU chapter for more information on adjusting these other settings.

SEQUENCES

The DM8's built-in sequencer lets you record, overdub, edit, play back, and loop Sequences (drum patterns). You can adjust settings like the tempo, time signature, and quantization for a Sequence.

To access the sequencer, press the module's SEQ button and navigate the menus or adjust the settings accordingly.



For more information on using the sequencer, see the SEQUENCES chapter.

Important: At any given time, the DM8 module has a Kit selected and a Sequence selected.

If you change the Sequence, this will change your current Kit to the one that is associated with that Sequence.

If you change the Kit, this will NOT change the current Sequence. However, if you then play the current Sequence, the chords or "hit groups" may sound unusual. In this case, we recommend muting Layer B of that Kit's Accompaniment (see EDITING VOICE & ACCOMPANIMENT PARAMETERS for more information) or muting the Accompaniment altogether by pressing MUTE ACCOMP.

STORING DATA

The DM8 module can store the information you enter for use in future sessions. This includes Kits you edit or record, Sequences you edit or record, Instrument or Kit parameters, and more. Furthermore, while there are several slots for User Kits and Sequences, you can also save over the Presets (the first 100 Kits or the first 75 Sequences).

To store a Kit, Instrument, or Sequence, press the DRUM KIT or SEQ button (respectively) to select the item you want to store, then press the STORE button. (If you are storing a Kit or Instrument, you will be asked to specify which.)

Use the CURSOR UP / DOWN buttons and VALUE UP / DOWN buttons or VALUE DIAL to select the "From" Kit or Sequence (the one you want to save) and the "To" Kit or Sequence (where you want to save it to).

For more information on using storing data, see the STORING & COPYING DATA chapter.

UTILITY

The Utility Menu lets you control global settings such as the output routing as well as metronome, MIDI, and tempo settings. You can also transmit SysEx data in this menu as well as re-initialize the DM8 (i.e., return it to its factory settings).

To access the Utility Menu, press the module's UTILITY button and navigate the menus or adjust the settings accordingly.

For more information, see the UTILITY MENU chapter.

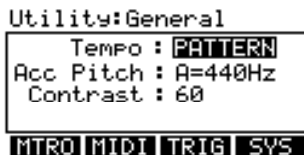
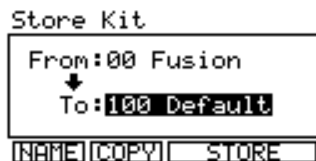
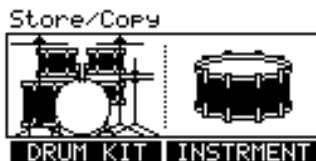

REAR PANEL FEATURES

- POWER SWITCH** – Turns the module on and off.
- POWER IN** – Connect the included AC adapter to this input, then connect the adapter to a power source.

WARNING: Use only the included Alesis power supply with the DM8 module.

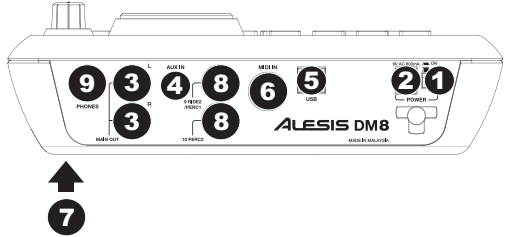

- MAIN OUT** – Use 1/4" TRS cables to connect these outputs to an amplifier or speaker system. The volume of these outputs is controlled by the VOLUME knob on the top panel.
- AUX IN** – Connect an external sound source, such as a CD player, to this input using a stereo 1/8" cable.
- USB** – Use a standard USB cable to connect the module to your computer via this USB port. This connection allows the module to send MIDI messages via USB to an external drum software module. You can also transmit SysEx files over this connection.
- MIDI IN** – Use a standard five-pin MIDI cable to connect this input to the MIDI OUT of an external MIDI device.
- CABLE SNAKE CONNECTION** – Connect the included cable snake to this connector, then connect the cables to their respective triggers.
- TRIGGER INPUTS** – If you have additional drum pads, cymbal pads, or other triggers, you can use standard 1/4" cables to connect them to the "RIDE 2/PERC1" or "PERC2" TRIGGER INPUTS. Dual-zone pads or cymbals (e.g., a drum with head and rim triggers or a cymbal that can produce bow and bell sounds) will require TRS cables to trigger both zones.
- HEADPHONES OUTPUT** – Connect your 1/4" headphones to this output. You can adjust the volume of this output with the VOLUME knob on the module's top panel.

Note: The module's HI-HAT CONTROL TRIGGER INPUT does not support keyboard-style expression pedals.

TOP PANEL FEATURES

- VOLUME** – Adjusts the volume level of the MAIN OUT and HEADPHONES OUTPUT.
- METRONOME ON / OFF** – Turns the metronome on or off.
- LCD** – Displays system menus, parameters, and other settings as you use the DM8.
- F-BUTTONS (1-4)** – These buttons allow you to navigate the menus shown in the LCD. Press an F-BUTTON to select the "virtual" button or tab shown above it in the LCD.
- CURSOR UP / DOWN** – Use these buttons to move (vertically) through the available parameters shown in menus in the LCD.

Note: Pressing CURSOR DOWN from the Main Screen allows you to adjust overall parameters for the current Kit.

- VALUE DIAL** – Turn this wheel to increase and decrease values and settings shown in the LCD.
- VALUE UP / DOWN** – Use these buttons to increase and decrease values and settings shown in the LCD. These may be easier to use than the VALUE DIAL when making incremental adjustments to your parameters.
- EXIT** – Press this button to return to the previous menu shown in the LCD.



9. **DRUM KIT** – Returns the LCD to the Main Screen. From here, you can select the current Kit with the VALUE DIAL or VALUE UP / DOWN buttons.
10. **UTILITY** – Enters the Utility Menu, which allows you to set certain "global" parameters that affect the DM8's overall operation (e.g., tempo, MIDI, output routing, trigger sensitivity, etc.). (See the Reference Manual for more information.)
11. **EXT TRIG** – Allows you to adjust parameters related to triggering. Customizing these parameters changes the feel and responsiveness of the Kit.
Note: Changes to these parameters will affect ALL Kits.
12. **NOTE CHASE** – Turns Note Chase on or off. When Note Chase is on, striking a trigger automatically selects it for editing. Alternatively, you can select a trigger by highlighting the trigger field in the LCD with the CURSOR UP / DOWN buttons then using the VALUE UP / DOWN buttons or VALUE DIAL.
13. **EDIT INST** – Press this button to edit the Instrument assigned to a trigger input. While editing, pressing it toggles between the two Layers of the trigger. The current Layer (A or B) will be highlighted on the top-right corner of the LCD.
14. **EDIT ACCOMP** – Press this button to adjust the settings for your Accompaniment. The adjustable parameters will be shown in the LCD.
15. **PREVIEW** – Press this button to preview the sound of the current trigger. This can be useful when programming the DM8 if it is not connected to your drum kit, if it is not convenient to strike the pads, etc.
16. **STORE** – Press this button to save changes made to the current Kit, Sequence, trigger settings, or global settings. Use the VALUE DIAL or VALUE UP / DOWN buttons to select a destination where the current Kit or Sequence will be stored. When saving a Kit, its Instruments and all its parameters will also be stored. When saving a Sequence, it will remember its corresponding Kit and Accompaniment.
17. **SEQ** – Press this button to access the module's Sequencer where you can create and edit drum and accompaniment patterns.
18. **MUTE DRUMS** – Press this button to mute the drum track of a Sequence.
19. **MUTE ACCOMP** – Press this button to mute the Accompaniment track of a Sequence.
20. **STOP** – Stops playback of the current Sequence. Hold down STOP and turn the VALUE DIAL to "scrub" forwards and backwards through the Sequence. Hold down STOP and press VALUE UP / DOWN to "step" forwards or backwards through each "event" in the Sequence. While navigating the Sequence in these ways, you will hear the Sequence play as you move through it.
21. **PLAY / ⏪** – Plays the current Sequence. You can also hold down STOP and press this button to move back to the previous bar in the Sequence.
22. **RECORD / ⏩** – Records a new Sequence. You can also hold down STOP and press this button to move to the next bar in the Sequence.
23. **TAP TEMPO** – Tap this button at the desired rate to enter a new tempo for the Sequence. You can also change the tempo by holding down the TAP TEMPO button and using the VALUE DIAL or VALUE UP / DOWN buttons.

KITS, VOICES, ACCOMPANIMENT & INSTRUMENTS

The DM8 Module has 100 Preset Kits and 100 User Kits, which you can select from the Main Screen. Each Kit is a collection of Voices – or drum sounds – that are assigned to each trigger on the DM8. When a trigger is struck, that Voice will sound.

Each Voice consists of two Layers, each with its own Instrument. Both Layers sound together, helping to create powerful composite and layered sounds and timbres for a more dynamic performance.

You can change the sound of your performance by selecting different Kits or by editing the Kits by changing the Instruments that make up each Voice. You can also edit various parameters of each Instrument themselves (e.g., level, panning, decay, reverb, etc.) in each Kit.

IMPORTANT: At any given time, the DM8 module has a Kit selected and a Sequence selected. If you change the Sequence, this will change your current Kit to the one that is associated with that Sequence. If you change the Kit, this will NOT change the current Sequence. However, if you then play the current Sequence, the chords or "hit groups" may sound unusual. In this case, we recommend muting Layer B of that Kit's Accompaniment (see EDITING VOICE & ACCOMPANIMENT PARAMETERS for more information) or muting the Accompaniment altogether by pressing MUTE ACCOMP.

SELECTING A KIT

1. Press the DRUM KIT button to bring up the Main Screen.
2. Use the VALUE UP / DOWN buttons or the VALUE DIAL to select a Kit. The Kit number, name, and graphic will change as you move through the different Kits.
3. Hit the triggers to try out the sounds of the Kit.
To set levels that can be recalled with the Kit, set the "Level" parameters for the individual triggers (see EDITING VOICE & ACCOMPANIMENT PARAMETERS in this chapter) and/or the entire Kit (see DRUM KIT SETUP in this chapter).



EDITING INSTRUMENTS IN A KIT

1. Press DRUM KIT to go to the Main Screen.
2. Press EDIT INST. The top of the screen will show the number and name of the Kit whose Instruments (drum voices) you will be editing.
3. Select INST (F1). The new screen will show:
 - a. the trigger Voice you are editing (the Kit number and name of the Voice will be shown)
 - b. the Layer (each Voice consists of two layers, each with its own Instrument)
 - c. the Category (the type or "class" of drum sound currently assigned to that Layer)
 - d. the Instrument (the drum sound for that Layer)
4. Select the Voice whose Instrument you want to change by pressing NOTE CHASE then striking the desired trigger. Alternatively, you can highlight the Voice (next to the Kit number) using the CURSOR UP / DOWN buttons to highlight it and use the VALUE UP / DOWN buttons or VALUE DIAL to change it.
5. Select which Layer of that Voice you will edit by pressing EDIT INST. It will toggle between Layer A and B.
6. Select the Category you want to assign to that Voice by pressing CURSOR UP / DOWN to highlight the Category field, then use the VALUE UP / DOWN buttons or VALUE DIAL to change it.
7. Select the Instrument for that Layer by pressing CURSOR UP / DOWN to highlight the Instrument field, then use the VALUE UP / DOWN buttons or VALUE DIAL to change it. To hear the currently selected sound, strike the corresponding trigger or press PREVIEW on the module.

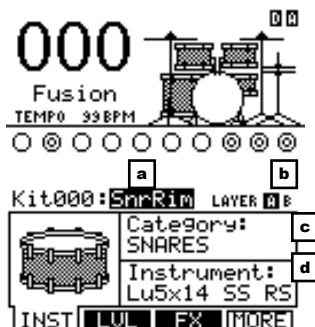

Note: The available Instruments for the hi-hat and ride cymbal Categories are pre-defined sets of sounds designed to work together (e.g., the hi-hat can produce open, closed, "chick" or splash sounds). You can assign any Category or Instrument you like for the hi-hat and ride cymbal triggers, but because other Instruments are designed to work differently, the results will vary.

EDITING ACCOMPANIMENT IN A KIT

1. When you are in the Kit whose Accompaniment you want to edit, press EDIT ACCOMP. The screen will show:
 - a. the number of the Kit whose Accompaniment you will be editing
 - b. the Layer (the Accompaniment consists of two layers, each with its own Instrument)
 - c. the Category (the type or "class" of sound currently assigned to that Layer)
 - d. the Instrument (the sound for that Layer)
2. Select which Layer of the Accompaniment you will edit by pressing EDIT ACCOMP. It will toggle between Layer A and B.
3. Select the Category you want to assign to that Voice by pressing CURSOR UP / DOWN to highlight the Category field, then use the VALUE UP / DOWN buttons or VALUE DIAL to change it.
4. Select the Instrument for that Layer by pressing CURSOR UP / DOWN to highlight the Instrument field, then use the VALUE UP / DOWN buttons or VALUE DIAL to change it. To hear the currently selected sound, strike the corresponding trigger or press PREVIEW on the module.



Useful information about Accompaniment:

The Accompaniment track includes the bass line and other synthesizer sounds that you hear when the module is playing a Sequence. The drum track and Accompaniment track play simultaneously, and you can mute either of the tracks as they play with the MUTE DRUMS or MUTE ACCOMP buttons.

Just as each drum Instrument of a Kit belongs to a Category (e.g., KICKS, SNARES, LATIN PERC, etc.) Accompaniment Instruments are also grouped into several Categories: BASS, SYN BASS, FX, and HIT GROUPS.

Also, just like drum Voices, the Accompaniment has two Layers of Instruments. Layer A is usually the bass line. Layer B is often something different – another melodic line, chords, or "hits."

Instrument changes within or between the BASS and SYN BASS Categories may sometimes be desirable – the bass will have a different tone or quality while the bass line itself (the notes you hear) remains the same. However, if you edit the Instruments in the FX or HIT GROUPS Categories, it may dramatically change the way a Sequence sounds if it uses that Kit.

In this case, we recommend muting that Layer of that Kit's Accompaniment (see EDITING VOICE & ACCOMPANIMENT PARAMETERS for more information) or muting the Accompaniment altogether by pressing MUTE ACCOMP.

EDITING VOICE & ACCOMPANIMENT PARAMETERS

While editing your Kits by changing the Instruments in a drum Voice or the Accompaniment, you can also edit various parameters that affect each Layer and, therefore, the Instrument on that Layer. You can do this for the drum Voices or the Accompaniment, though some parameters below may only be editable for one of these.

Note: The DM8 will retain any changes you make to the Instruments or parameters as you move between the various Kits.

1. Press DRUM KIT to go to the Main Screen.
2. Press EDIT INST to edit drum Voice parameters or EDIT ACCOMP to edit Accompaniment parameters. The top of the screen will show the number and name of the Kit whose Instruments (drum Voices or Accompaniment) you will be editing.
3. Select INST (F1). The new screen will show:
 - a. the trigger Voice you are editing (the Kit number and name of the Voice will be shown). If you are editing the Accompaniment, this will read "Accomp."
 - b. the Layer (each trigger sound or Accompaniment track consists of two Layers, each with its own Instrument)
 - c. the Category (the type or "class" of drum sound or Accompaniment currently assigned to that Layer)
 - d. the Instrument (the drum or Accompaniment sound for that Layer)

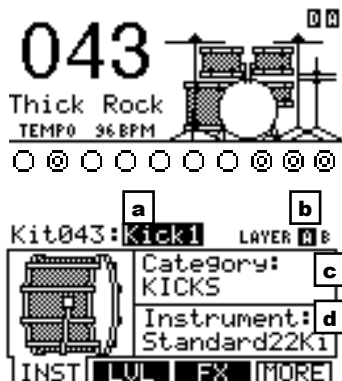

4. If you are editing a Voice, select the Voice whose Instrument you want to change by pressing NOTE CHASE then striking the desired trigger. Alternatively, you can highlight the Voice (next to the Kit number) using the CURSOR UP / DOWN buttons to highlight it and use the VALUE UP / DOWN buttons or VALUE DIAL to change it. (This step is not necessary when editing Accompaniment.)

Note: You can also change the current Voice in this fashion in any of the subsequent menus. You can also toggle between Layers by pressing EDIT INST whenever the "Layer: A B" selector is shown on the upper right corner of the LCD.

5. Select any of the options at the bottom of the LCD using the F-BUTTONS. Use CURSOR UP / DOWN to move through the menu items and VALUE UP / DOWN or the VALUE DIAL to adjust the settings.

- **LVL (F2, 1st page):**

- **Level:** The volume level for the selected Layer (01-99 or "OFF").
- **Pan:** The panning for the selected Layer ("L50" to "MID" to "R50").
- **Attack:** The volume level of the initial attack of the note (00-99). This parameter is only available when editing Accompaniment.
- **Decay:** How long the sound can be heard before decaying to silence (00-99 or "OFF").

Note: Setting this parameter to "OFF" disables the Decay parameter and the sound will be heard for its entire duration with no "shaping."

- **FX (F3, 1st page):**

- **Reverb:** The amount of reverb on the Voice (00-99).
- **Effects:** The Voice volume level sent to the DM8's effects processor (00-99).
- **EQ/Comp:** This sends the Voice to the DM8's equalizer and compressor ("ON" or "OFF").



- **TONE (F1, 2nd page):**

- **Semitone:** Tunes the Instrument ± 12 semitones.
- **Fine Tune:** Tunes the Instrument ± 50 cents.
- **Filter:** The cutoff frequency for the type of filter (see below) (00-99).
- **Type:** The type of filter ("LOPASS" or "HIPASS").



- **DYN (F2, 2nd page):**

- **Vel>Decay:** The velocity of a note will control the decay time of its sound (±00-99). With a positive value, higher-velocity notes will have a longer decay time. With a negative value, higher-velocity notes will have a shorter decay time.

```
Kit043:Kick          LAYER A B
Vel>Decay : 00
Vel>Filtr : 00
Vel>Level : 90
Vel>Pitch : 00
TONE DYN OTHR BACK
```

- **Vel>Filtr:** The velocity of a note will control the filter cutoff (±00-99).
- **Vel>Level:** This lets you set how velocity-sensitive the Instrument is (00-99). The higher the setting, the greater the dynamic range you'll have while playing. At "00," there will be no dynamic variation at all.
- **Vel>Pitch:** The velocity with which you strike the trigger will control the sound's pitch (±00-99). With a positive value, stronger hits will increase the pitch. With a negative value, stronger hits will decrease the pitch. (This parameter is not available for anything in the BASS or SYN BASS Categories when editing the Accompaniment.)

- **OTHR (F3, 2nd page):**

- **Output:** The output through which the Voice or Accompaniment will be sent. When "MAIN" is selected, the Voice or Accompaniment will be sent out of the MAIN OUT. When "AUX" is selected, the Voice or Accompaniment will be sent out of the AUX OUT.

```
Kit043:Kick
Output : MAIN
Priority : MEDIUM
MuteGroup : OFF
Playback : POLY
TONE DYN OTHR BACK
```

Note: If your Utility Menu setting for the "Output" is set to "Main>Aux," the "AUX" option here will show up as "AUX (N/A)." This is because the AUX OUT signal is "mirroring" the MAIN OUT signal. See the GENERAL menu part of the UTILITY MENU section for more information.

- **Priority:** How high the Voice's or Accompaniment's "polyphony priority" is – "LOW," "MEDIUM," or "HIGH." "Polyphony" is the simultaneous sounding of Instruments (e.g., if you strike multiple triggers at the same time, like the hi-hat, snare, and kick drum). The DM8 has 64-voice polyphony, meaning up to 64 voices can sound at the same time. After exceeding that limit, Voices or Accompaniment with lower polyphony priority may be silenced so the ones with higher priority can sound.

- **MuteGroup:** The MuteGroup the Voice is assigned to, if any (01-09 or "OFF"). When two or more triggers are assigned to a MuteGroup, a Voice that is currently sounding will be silenced when another Voice from that MuteGroup begins. There are nine available MuteGroups.

Example: If your "Kick1" (kick drum) and "SnrHd" (snare drum head) are assigned to the same MuteGroup, the decay of your snare drum will be cut off when you hit the kick drum and vice versa.

Note: The MuteGroup function is especially useful for setting up multiple sounds shared by the same instruments, like "open" vs. "closed" triangle sounds or struck vs. stroked güiros.

Note: The default Playback setting is POLY, which is more natural for acoustic drums. MONO is a useful setting for synth drums or for emulating older drum machines.

- **Playback:** Indicates whether repeated strikes of the same trigger will be considered polyphonic (POLY) or monophonic (MONO). When set to "POLY" (the default), successive strikes of the same trigger will be allowed to sound simultaneously as polyphony (see "Priority" above). When set to "MONO," successive strikes of the same trigger will silence previous ones.

EDITING MIDI PARAMETERS

This page allows you to edit various MIDI-related settings for each trigger. To edit them,

1. Press DRUM KIT to go to the Main Screen.
2. Press EDIT INST. The top of the screen will show the number and name of the Kit whose Instruments (drum voices) you will be editing.
3. Select MIDI (F2). The top of the new screen will show the trigger Voice you are editing. You can select another trigger by pressing NOTE CHASE then striking the desired trigger. Alternatively, you can highlight the Voice (next to the Kit number) using the CURSOR UP / DOWN buttons to highlight it and use the VALUE UP / DOWN buttons or VALUE DIAL to change it.

Note: You can also change the current Voice in this fashion in any of the subsequent menus.

4. When you have selected the Voice you want to edit, select either of the options at the bottom of the LCD using the F-BUTTONS. Use CURSOR UP / DOWN to move through the menu items and VALUE UP / DOWN or the VALUE DIAL to adjust the settings:

a. **MIDI**

- **MIDI Chan:** The MIDI channel over which the trigger will transmit MIDI messages.
- **MIDI Note:** The MIDI note that will be transmitted. The number is the MIDI Note number; the corresponding musical note is shown next to it. (**Note:** The MIDI note for the hi-hat and ride cymbals is fixed and can not be reassigned.)
- **Gate Time:** The duration of the note sent from the trigger when struck. The available range is from 00-99 ms, then note values (1/32, 1/16, 1/8, 1/4, and 1/2 – with regular and triplet divisions for each value), or "OFF."
- **Note Off:** How the MIDI Note Off message is sent. When "NOT SENT" is selected, a MIDI Note Off will not be transmitted. When "SENT" is selected, a MIDI Note Off will be sent after the length of time specified by the Gate Time (above). When "ALTERNATE" is selected, striking a trigger once will cause it to send its MIDI Note; striking it a second time will cause it to send a MIDI Note Off.

b. **CHORD / ARP:** Select "OFF," "CHORD," or "ARPEGGIO." (**Note:** The CHORD / ARP function is not available for the hi-hat and ride cymbals.)

- **OFF:** The trigger will transmit only the MIDI note assigned to it.
- **CHORD:** The trigger will transmit up to four MIDI notes simultaneously whenever it is struck. You can select the additional three notes here. The number is the MIDI Note number; the corresponding musical note is shown next to it in parentheses.
- **ARPEGGIO:** The trigger will transmit up to four MIDI notes but will "rotate" through them with each strike (e.g., the first time the trigger is struck, it will send its first MIDI note; the next time, it will send Note #2; the next time, it will send Note #3). You can select the three additional notes here. The number is the MIDI Note number; the corresponding musical note is shown next to it in parentheses.



EDITING EFFECTS PARAMETERS

On this page, you can apply a variety of effects such as reverb, chorus, or delay to the entire Kit:

1. Press DRUM KIT to go to the Main Screen.
2. Press EDIT INST. The top of the screen will show the number and name of the Kit whose effects you will be editing.
3. Select FX (F4).
4. Select any of the options at the bottom of the LCD using the F-BUTTONS. Use CURSOR UP / DOWN or the VALUE DIAL to adjust the settings:



- a. **RVB (reverb)**
 - **Type:** The kind of reverb applied (most often, types of reverb are named after the kind of room whose reverb is being emulated). To disable effects on the Kit, select "OFF."
 - **Size:** The size of the virtual "room" as designated by the reverb Type.
 - **Color:** The amount of high-frequency dampening of the reverb, which affects its tone.
 - **Level:** The level of the reverb.
- b. **FX (other effects)**
 - **Type:** The kind of effect applied. To disable effects on the Kit, select "OFF." The effects – and their editable parameters – are as follows:



FLANGER: Flanging is a kind of phasing or phase-shifting. The DM8's flangers have the same editable parameters.

Mono Flanger: Traditional flanging effect.

Stereo Flanger: Flanger with a simulated stereo effect, creating a "wider" sound.

XOver Flanger: The flanging effect "moves" around the stereo field.

Rate: The speed at which the sound will "flange."

Depth: How much of the delayed (or phase-shifted) signal is added to the original.

Feedback: How much of the flanging signal will be routed back into the flanger again, which intensifies the effect.

Level: The volume level of the flanging signal.

CHORUS: A chorus effect is produced by adding a slightly delayed and slightly pitch-shifted "wet" signal to the original ("dry") signal, producing a sound with a depth similar to that of a string section or choir. The DM8's chorus effects have the same editable parameters.

Mono Chorus 1: Traditional chorus effect.

Mono Chorus 2: A variation of the traditional chorus effect.

Stereo Chorus: Chorus with a simulated stereo effect, creating a "wider" sound.

XOver Chorus: The chorus effect "moves" around the stereo field.

Rate: The speed of the modulation of the chorus (or how much the signal is delayed).

Depth: How much the chorus's delay varies.

Feedback: How much of the delayed signal will be routed back into the processor again, which creates a thicker chorus effect.

Level: The volume level of the chorus signal.

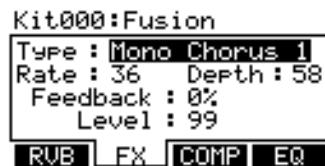

VIBRATO: Vibrato is produced by causing the pitch of a note to "waver" slightly back and forth, creating a subtle pulsing effect. This effect is often created by players of string instruments and horns. The DM8's vibrato effects have the same editable parameters.

Mono Vibrato: Traditional vibrato effect.

Vibrato: Vibrato with a simulated stereo effect, creating a "wider" sound.

Rate: The speed of the vibrato (how quickly the pitch wavers).

Depth: How much the pitch wavers from the center/original pitch.

Level: The volume level of the vibrato.

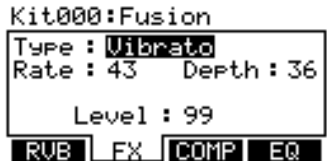

DELAYS: A delay effect is a kind of echo, which varies depending on the size of the room it emulates and the rate, volume, and decay of the echo. The DM8's delay effects have some common parameters with some notable differences.

Mono Doubler: A very quick delay that creates a "double-hit" effect.

Doubler: A very quick delay that creates a "double-hit" effect in a stereo field.

Delay: The speed of the delay/echo.

Level: The volume level of the delayed signal.

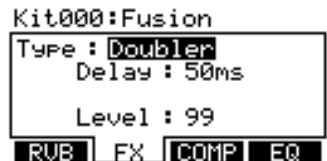

Mono Slapback: A quick – almost immediate – delay.

Slapback: Quick delay with a simulated stereo effect, creating a "wider" sound.

Delay: The speed of the delay/echo.

Level: The volume level of the delayed signal.

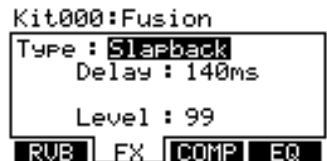

Mono Delay: A traditional delay effect.

Delay: The speed of the delay/echo.

Feedback: How much of the echo will be routed back into the processor again, which creates a longer-lasting, intensified echo effect.

Damp (dampening): The amount of low- and high-frequency dampening of the echo. At negative values, the sound of the echo gets progressively duller, which is the most "natural" echo effect. This is also useful for simulating tape echo. At positive values, the sound of the echo gets progressively thinner.

Level: The volume level of the delayed signal.



Delay: A traditional delay with two independent delay lines.

LDelay / RDelay (left/right delay): The speed of the delay/echo. This can be set independently for the left and right channels to create an even wider, more varied sound.

LFBk / RFBk (left/right feedback): How much of the echo will be routed back into the processor again, which creates a longer-lasting, intensified echo effect. This can be set independently for the left and right channels to create an even wider, more varied sound.



Damp (damping): The amount of low- and high-frequency dampening of the echo. At negative values, the sound of the echo gets progressively duller. At positive values, the sound of the echo gets progressively thinner.

Level: The volume level of the delayed signal.

XOver Delay: This delay has a stereo effect. The echo pans around the stereo field.

LDly / RDly (left/right delay): The speed of the delay/echo. This can be set differently for the left and right channels to create an even wider, more varied sound.

Feedback: How much of the echo will be routed back into the processor again, which creates a longer-lasting, intensified echo effect.

Damp (damping): The amount of low- and high-frequency dampening of the echo. At negative values, the sound of the echo gets progressively duller. At positive values, the sound of the echo gets progressively thinner.

Level: The volume level of the delayed signal.

PingPong: This delay has a stereo effect, but instead of echoing in both left and right channels simultaneously, the echo alternates between them.

Delay: The speed of the delay/echo.

Feedback: How much of the echo will be routed back into the processor again, which creates a longer-lasting, intensified echo effect.

Damp (damping): The amount of low- and high-frequency dampening of the echo. At negative values, the sound of the echo gets progressively duller. At positive values, the sound of the echo gets progressively thinner.

Level: The volume level of the delayed signal.



c. **COMP** (compression)

- **Type:** The kind of compression applied. To disable the dynamic processor on the Kit, select "OFF."
- **Compress** (compression): The compression ratio applied to the signal from the Kit.
- **Out Level** (output level): The output level of the compressor. This is parameter is useful for boosting the Kit's signal if its volume has decreased due to the compression.



d. **EQ** (equalization)

- **LF Gain** (low-frequency gain): The amount of boost or cut of the low frequency band (as determined by the LF Freq setting).
- **LF Freq** (low frequency): The frequency the LF Gain will boost or cut.
- **HF Gain** (high-frequency gain): The amount of boost or cut of the high frequency band (as determined by the HF Freq setting).
- **HF Freq** (high frequency): The frequency the HF Gain will boost or cut.



DRUM KIT SETUP

While selecting Kits, you can enter the Drum Kit Setup Menu to access a few useful parameters pertaining to the current Kit.

Note: The DM8 will retain any changes you make to the Instruments or parameters as you move between the various Kits.

1. Press DRUM KIT to go to the Main Screen.
2. Use the VALUE UP / DOWN buttons or VALUE DIAL to select a Kit.
3. Press CURSOR DOWN to enter the Drum Kit Setup Menu for that Kit.
4. Select any of the options at the bottom of the LCD using the F-BUTTONS. Use CURSOR UP / DOWN to move through the menu items and VALUE UP / DOWN or the VALUE DIAL to adjust the settings.

- **MAIN (F1):**

- **Kit Level:** The overall volume level for the Kit (00-99)
- **Graphic:** The image used to identify the Kit on the main screen.



- **MIDI (F2):**

- **MIDI Chan:** The MIDI channel over which the module will send out Program Change messages (01-16 or "OFF"). (When set to "OFF," the other parameters below will not be displayed.) You will need to set this properly when using the DM8 module to play sounds on another module.
- **Ext Prog#:** The Program Change number the module will send out (00-99).
- **MSB:** Sets the Most Significant Byte when using sounds on an external module that requires bank changes (00-127 or "OFF").
- **LSB:** Sets the Least Significant Byte when using sounds on an external module that requires bank changes (00-127 or "OFF").

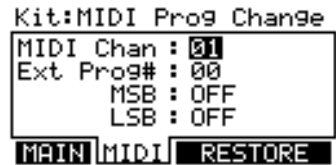

- **RESTORE (F3 or F4):**

- **Restore:** Returns the Kit to its original factory settings. Any edits you made to its Instruments, Accompaniment, etc. will be discarded. To restore the original settings, press RESTORE (F1 or F2). To cancel, press EXIT.



SEQUENCES

A Sequence is a recorded pattern stored in the DM8 module that includes drums and Accompaniment. The drum part of the Sequence includes the Kit sounds (Instruments) as well the recorded pattern itself. The Accompaniment is the music that plays along with the drum part.

Sequences can be recorded, edited, looped, and stored. You can also mute the drum part and/or Accompaniment while playing a Sequence.

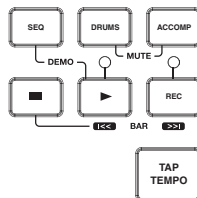

To hear a demo Sequence, simply hold down SEQ and press PLAY.

Important: At any given time, the DM8 module has a Kit selected and a Sequence selected.

- If you change the Sequence, this will change your current Kit to the one that is associated with that Sequence.
- If you change the Kit, this will NOT change the current Sequence. However, if you then play the current Sequence, the chords or "hit groups" may sound unusual. In this case, we recommend muting Layer B of that Kit's Accompaniment (see EDITING VOICE & ACCOMPANIMENT PARAMETERS for more information) or muting the Accompaniment altogether by pressing MUTE ACCOMP.

Note: Whenever you edit a Sequence or make changes to any parameters, an "E" will appear in the upper-right corner of the main screen of the Sequencer to indicate this. In order to retain these settings for future sessions, you must store the Sequence (see STORING SEQUENCES under the STORING & COPYING DATA chapter).



PLAYING SEQUENCES

1. Press SEQ to enter the main screen of the Sequencer.
2. Use the CURSOR UP / DOWN buttons to highlight the "Seq" field at the top of the LCD.
3. Use the VALUE UP / DOWN buttons or VALUE DIAL to select a Sequence.
4. You can press PLAY to play the Sequence, or you can use the CURSOR UP / DOWN buttons to select settings to edit for that Sequence. Use the VALUE UP / DOWN buttons or the VALUE DIAL to change the settings:



- **Tempo:** The speed (in BPM or beats per minute) of the sequence. You can set the tempo here, or you can press the TAP TEMPO button several times at the desired tempo to enter a new one. The range is 30 – 300 BPM.

Note: If the Tempo field of the Utility Menu's main page is set to "GLOBAL," the letter "G" will be shown. If the Clock In field of the Utility Menu's MIDI page is set to "RECEIVE," the letter "E" will be shown.

- **Time Sig** (Time Signature): The time signature of the sequence. The first number indicates how many beats there are in a measure; the second number indicates the note value of those beats. **(Example: "3/4" means one measure is three quarter notes long. "12/8" means one measure is twelve eighth notes long.)**
 - **#Bars:** The number of bars in the Sequence, which you can set from 1 to 99.
 - **Loop:** You can set the Sequence to loop or to play only once.
5. Press PLAY to play the Sequence. A "▶" will appear on the upper right-hand corner of the LCD.

To mute the drums or Accompaniment in the Sequence, press the MUTE DRUMS or MUTE ACCOMP button, respectively. The upper right-hand corner of the LCD indicates whether the drums ("D") and Accompaniment ("A") are muted. When unmuted, the letter is highlighted. (This is a useful tool when you want to play your own drum patterns to the Accompaniment or vice versa.)



RECORDING SEQUENCES

1. Press SEQ to enter the main screen of the Sequencer.
2. Press the REC tab (F1).
3. Use the CURSOR UP / DOWN buttons to select settings to edit for that Sequence. Use the VALUE UP / DOWN buttons or the VALUE DIAL to change the settings:
 - **Track:** The track of the Sequence over which you will be recording – "DRUMS" or "ACCOMP."
 - **Rec Type:** How the performance will be recorded. When "RECORD" is selected, the performance you record will replace the recording on that Track of the Sequence. When "OVERDUB" is selected, the performance you record will be added to the existing recording on that Track of the Sequence.
 - **Quantize:** The quantization level of the recording. When on, this function will "snap" all recorded notes to the nearest interval of that measure, which you select. (For instance, if you select "1/8," any notes you record that do not fall on an eighth-note pulse will be shifted automatically to the nearest one.) The range is 1/4 – 1/64 (regular or triplet) and "OFF."
 - **Swing:** The amount of swing applied to the recording – 54%, 58%, 62%, or "OFF."
6. Press the module's REC button and record your performance.
7. When you are finished recording, press STOP.



EDITING SEQUENCES (DRUMS)

The editing screen for a Sequence's drum part allows you to see a visual representation of the drum pattern.

1. Press SEQ to enter the main screen of the Sequencer.
2. Use the CURSOR UP / DOWN buttons to select the "Seq" field at the top of the LCD, then use the VALUE UP / DOWN buttons or the VALUE DIAL to select the Sequence you want to edit.
3. Press REC (F1). Use the CURSOR UP / DOWN buttons to select the "Track" field, then use the VALUE UP / DOWN buttons or the VALUE DIAL to select "DRUMS."

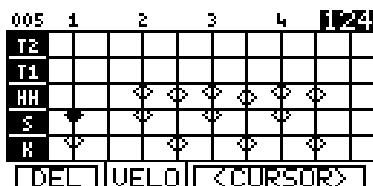

4. Press EDIT (F2). You will see a grid on the screen. The diamonds indicate MIDI notes or "events"; the black diamond is the currently selected event. Each column represents an interval/subdivision of the bar. Each row of the grid represents a drum Voice:
 - **K** = kick drum
 - **S** = snare drum
 - **HH** = hi-hat
 - **T1** = 1st tom
 - **T2** = 2nd tom
 - **T3** = floor tom
 - **C** = crash cymbal
 - **R** = ride cymbal
 - **P1** = Ride2 / Perc1
 - **P2** = Perc2
 - The numbered rows correspond to available MIDI note numbers.

5. You can use the following controls to edit your Sequence in this screen:
 - CURSOR UP / DOWN scrolls up or down, allowing you to view other parts of the editing grid.
 - You can move through the Sequence in several ways:
 - **by bar:** Press and hold STOP and press either PLAY / ⏪ or RECORD / ⏩ to step through the Sequence bar by bar.
 - **by event:** Use CURSOR < / > (F3 and F4) or press and hold STOP and use the VALUE UP / DOWN to step through the Sequence event by event. Each event will play as it is selected.
 - **"scrubbing":** Press and hold STOP and turn the VALUE DIAL to move fluidly through the Sequence. The Sequence will play back at the speed with which you rotate the VALUE DIAL.
 - VALUE UP / DOWN or the VALUE DIAL will either shift the event in time (earlier or later) or adjust its velocity (higher or lower), depending on the setting of the F2 button.
 - TIME / VELO (F2) lets you toggle between two views of the editing grid. When TIME is selected, using the VALUE UP / DOWN buttons or the VALUE DIAL will adjust the timing of the selected event, moving it forward or backward in the Sequence (the current "click" * number will be shown in the upper right-hand corner of the LCD). When VELO is selected, using the VALUE UP / DOWN buttons or the VALUE DIAL will adjust the velocity of the selected event, moving it higher or lower (the current velocity will be shown in the upper right-hand corner of the LCD).
 - DEL (F1) will delete the selected event from the Sequence. A window will ask you to confirm this choice before deleting it – select YES (F4), NO (F3), or TRAK (F1), which will delete the entire Sequence.
6. When you have finished making your edits, you can press EXIT or any button that will enter another screen (e.g., DRUM KIT, UTILITY, etc.). Your edits will be retained in the Sequence for this session. If you want to save your changes for future sessions, though, you will need to store them (see STORING & COPYING DATA for more information).

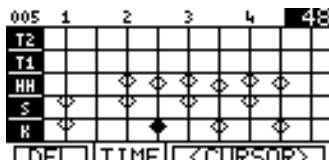

EDITING SEQUENCES (ACCOMPANIMENT)

The editing screen for a Sequence's Accompaniment is different from the one used to edit drums.

1. Press SEQ to enter the main screen of the Sequencer.
2. Use the CURSOR UP / DOWN buttons to select the "Seq" field at the top of the LCD, then use the VALUE UP / DOWN buttons or the VALUE DIAL to select the Sequence you want to edit.
3. Press REC (F1). Use the CURSOR UP / DOWN buttons to select the "Track" field, then use the VALUE UP / DOWN buttons or the VALUE DIAL to select "ACCOMP."
4. Press EDIT (F2). You will see a table of values. Each row represents a note or "event" in the Sequence. Each column represents the events' positions and parameters:

BAR	BEAT	CLK	NOTE	VELO	DUR
001	04	72	E1	119	47
001	04	72	C#4	96	23
002	01	00	D#4	90	23
002	01	24	E2	113	27

DEL EDIT <CURSOR>

- **Bar / Beat / Clk * :** The position of that event in the Sequence by bar, beat (within that bar), and click (within that beat). As you move down the table, you move through the Sequence.
- **Note:** The MIDI note being sent. (See next page for an explanation of how the sequencer refers to MIDI note numbers.)
- **Vel:** The velocity of the note (1-127).
- **Dur:** The duration of the note, measured in clicks (1-9999).

** Note: A "click" is just a subdivision of a quarter note in the DM8's sequencer, which defines its resolution. The DM8's resolution is 96 PPQN (pulses per quarter note), meaning each quarter note contains 96 clicks. This is helpful to know while editing Sequences' Accompaniment tracks if you are trying to shift a note into a precise position within a beat.*

5. You can use the following controls to edit your Sequence in this screen:
 - You can move through the Sequence in several ways:
 - **by bar:** Press and hold STOP and press either PLAY / ⏪ or RECORD / ⏩ to step through the Sequence bar by bar.
 - **by event:** Use CURSOR UP DOWN to step through the Sequence event by event. Each event will play as it is selected.
 - **"scrubbing":** Press and hold STOP and turn the VALUE DIAL to move fluidly through the events in the Sequence. The Sequence will play back at the speed with which you rotate the VALUE DIAL.
 - CURSOR < / > (F3 and F4) moves the cursor left or right, allowing you to select parameters to edit.
 - VALUE UP / DOWN or the VALUE DIAL adjusts the selected parameter.
 - DEL (F1) will delete the selected event from the Sequence. A window will ask you to confirm this choice before deleting it – select YES (F4), NO (F3), or TRAK (F1), which will delete the entire Sequence.
6. When you have finished making your edits, you can press EXIT or any button that will enter another screen (e.g., DRUM KIT, UTILITY, etc.). Your edits will be retained in the Sequence.

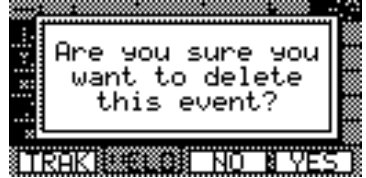

How the DM8 module's sequencer refers to MIDI note numbers:

When editing the Accompaniment track of a Sequence, you may notice the "Note" column contains the names of musical notes – A4, D#5, etc. However, the name of the note shown here may not be the actual musical note you hear.

On the Accompaniment tracks, the bass notes are mapped chromatically to MIDI notes A0 to A3. In other words, when the "Note" column shows a note from A0 to A3, which is the actual note you are hearing the bass play.

*The Accompaniment tracks also contain other (non-bass, non-drum) samples, such as chords, "hits," and other sounds. These samples are mapped to MIDI notes C#4 and above – but **not** in chromatic order, and the collection of samples usually does not contain all chromatic notes.*

SETTING UP THE CLICK TRACK

The "click track" is the metronome that plays as you record a Sequence. It is an aid to help you keep steady time. You can edit the click track settings from the Sequence page.

1. Press SEQ to enter the main screen of the Sequencer.
2. Press CLIK (F3). The top of the LCD will show the number of the Sequence but with the title "Click Track" to indicate you are editing the click track settings for the Sequencer. (**Note:** The click track settings apply to all Sequences.)
3. Use the CURSOR UP / DOWN buttons to select settings to edit. Use the VALUE UP / DOWN buttons or the VALUE DIAL to change the settings:



- **Count In:** Indicates when the click track will be heard before the Sequence records or plays. The number of bars can be specified in the "#Bars" parameter. When set to "REC ONLY," the count-in clicks will only be heard while recording a Sequence. When set to "REC + PLAY," the count-in clicks track will be heard while recording a Sequence and while playing back a Sequence.
- **#Bars:** The number of bars (2-16) that will be counted by the click track before the module actually begins recording. When set to "OFF," the Sequence will begin recording as soon as you press the module's REC button with no count-in. When set to "NOTE ON," the Sequence will begin recording from the first note that is sent to it (e.g., when you strike the first trigger, the Sequence will immediately start to record) with no count-in.

- **Metro (Metronome):** Indicates when the click track will be heard. When set to "REC ONLY," the click track will only be heard while recording a Sequence. When set to "REC + PLAY," the click track will be heard while recording a Sequence and while playing back a Sequence. When set to "MANUAL," the click track will be enabled or disabled by the module's METRONOME button.
 - **Sound:** The sound of the click track. When set to "AS METRO," the click track will use the Metronome settings from the Utility Menu (see the METRONOME (F1) part of the UTILITY MENU section for more information). When set to "SIMPLE," the click track will use the default metronome sound.
5. When you are finished, you can press EXIT or any button that will enter another screen (e.g., DRUM KIT, UTILITY, etc.).

EDITING QUANTIZATION SETTINGS

If the notes of a Sequence are not precisely aligned with a bar's subdivisions (e.g., eighth notes, 16th notes, etc.), quantization allows you to "snap" them into place automatically. This page lets you configure the quantization settings for your Sequences:

1. Press SEQ to enter the main screen of the Sequencer.
2. Use the CURSOR UP / DOWN buttons to select the "Seq" field at the top of the LCD, then use the VALUE UP / DOWN buttons or the VALUE DIAL to select the Sequence you want to edit.
3. Press QUAN (F4). The top of the LCD will show the number of the Sequence but with the title "Quantize" to indicate you are editing the quantization settings for that Sequence.
4. Use the CURSOR UP / DOWN buttons to select settings to edit for that Sequence. Use the VALUE UP / DOWN buttons or the VALUE DIAL to change the settings:
 - **Track:** The track of the Sequence – "DRUMS" or "ACCOMP" (Accompaniment) – to which quantization will be applied.
 - **Value:** The subdivision of a bar to which all notes will be quantized. For example, if this set to 1/16, all notes will be "snapped" to the nearest 16th note. The range is 1/4 – 1/64 (regular and triplet) and "OFF," which will turn quantization off.
 - **Swing:** The amount of swing applied to the quantization – 54%, 58%, 62%, or "OFF."
5. To apply quantization to the Sequence, press QUANTIZE (F1 or F2). A window will appear to ask you to confirm this choice. Quantization can not be undone, so consider this before confirming. Press FIX (F4) to apply quantization or CANCEL (F2 or F3) to cancel it.
6. When you are finished, you can press EXIT or any button that will enter another screen (e.g., DRUM KIT, UTILITY, etc.).

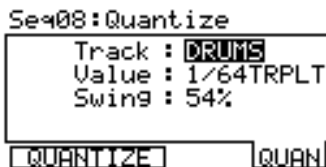

STORING & COPYING DATA

The DM8 module will "remember" changes to your Kit, Sequence, or Utility settings during a single session, but you will lose changes you have made once you turn the module's power off. To save your settings so you can recall them in future sessions, you need to "store" them accordingly.

NAMING

When storing or copying Kits or Sequences, you can press NAME (F1) to enter a new name for the selected Kit or Sequence. In a naming window, the selected character will be highlighted by the cursor. Press CURSOR </> (F3 and F4) to move the cursor. Use the VALUE UP / DOWN buttons or the VALUE DIAL to change the character. When you are done entering a name, press OK (F1).

STORING & COPYING KITS

1. Press DRUM KIT to enter the main screen.
 2. Press STORE. A new page will ask you to select DRUM KIT (F1 or F2) or INSTRUMENT (F3 or F4).
 3. Press DRUM KIT (F1 or F2). A new page titled "Store Kit" will appear.
 4. Use the CURSOR UP / DOWN buttons to highlight the "From" field of the window.
 5. Use the VALUE UP / DOWN buttons or VALUE DIAL to select the Kit you want to store.
 6. Use the CURSOR UP / DOWN buttons to highlight the "To" field of the window.
 7. Use the VALUE UP / DOWN buttons or VALUE DIAL to select a location to store the Kit. You can store it in any Kit number, though there are 100 empty User Kit slots (#100-199) to choose from.
 - If you want the Kit you are copying to keep the same name in its new location, press COPY (F2).
 - If you want the Kit you are copying to use the name of the Kit currently occupying the "To" slot, press STORE (F3 or F4).
 - If you want to rename the Kit you are copying, press NAME (F1). Use the VALUE UP / DOWN buttons or VALUE DIAL to scroll through the available characters, and use the CURSOR < and > (F3 and F4) buttons to move the cursor. Press OK (F1) when you are done entering a name, then press STORE (F3 or F4).
- Note:** By default, the "To" field will initially contain the same Kit number as the "From" field so you can quickly store changes to the current Kit.
8. A window will appear asking you to confirm your choice. Press CANCEL (F2 or F3) to cancel storing/copying the Kit. Press YES (F1) to store/copy it.

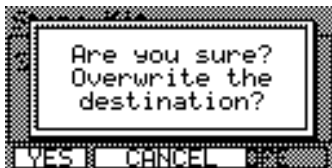

COPYING INSTRUMENTS

This page allows you to copy an Instrument from one Kit to an Instrument in another Kit. (You can also copy it to the same Kit, which effectively stores that Instrument in that Kit.)

Use the CURSOR UP / DOWN buttons to select the field you want to edit, and use the VALUE UP / DOWN buttons or VALUE DIAL to select a new entry in that field.

1. Press DRUM KIT to enter the main screen.
2. Press STORE. A new page will ask you to select DRUM KIT (F1 or F2) or INSTRUMENT (F3 or F4).
3. Press INSTRUMENT (F3 or F4). A new page titled "Copy Instrument" will appear.
4. Make sure the "Copy" field is selected then select the trigger whose Instrument you want to copy.
5. Select the "From" field.
6. Select the Kit that contains the Instrument you want to copy.
7. Select the "To" field.
8. Select the trigger where you want to copy the Instrument in the "Copy" field.
9. Select the "To" field then select the Kit where you want to copy the Instrument in the "Copy" field. You can copy it to any Kit, though there are 100 empty User Kit slots (#100-199) to choose from. Copying an Instrument over an existing one will overwrite it.

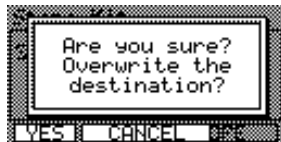

Note: By default, the "Copy" and "To" fields and "From" and "User" fields will initially contain the same settings so you can quickly store changes to the Instruments in your current Kit.

10. Press STORE (F3 or F4).
11. A window will appear asking you to confirm your choice. Press CANCEL (F2 or F3) to cancel storing the Kit. Press YES (F1) to store it.

STORING SEQUENCES

1. Press SEQ to enter the main Sequence page.
2. Press STORE. A new page titled "Store Sequence" will appear.
3. Use the CURSOR UP / DOWN buttons to highlight the "From" field of the window.
4. Use the VALUE UP / DOWN buttons or VALUE DIAL to select the Sequence you want to store.
5. Use the CURSOR UP / DOWN buttons to highlight the "To" field of the window.
6. Use the VALUE UP / DOWN buttons or VALUE DIAL to select a location to store the Sequence. You can store it in any Sequence number, though there are 25 empty User Sequence slots (#75-99) to choose from. Storing a Sequence over an existing one will overwrite it.

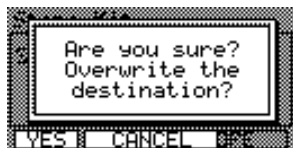
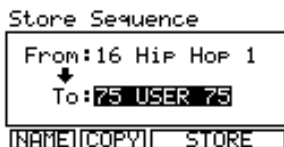

Note: By default, the "To" field will initially contain the same Sequence number as the "From" field so you can quickly store changes to the current Sequence.

7. Press STORE (F3 or F4).
8. A window will appear asking you to confirm your choice. Press CANCEL (F2 or F3) to cancel storing the Sequence. Press YES (F1) to store it.

STORING TRIGGER SETTINGS

Any changes you make to the parameters in the Ext. Trig Menu will remain for the current session but will return to their defaults if you turn off the module. We recommend storing your settings when you change them so you can use them in future sessions.

To store Ext. Trig settings:

1. Be sure you are in the Ext. Trig Menu by pressing EXT TRIG.
2. Press STORE.
3. A window will appear asking you to confirm your choice. Press CANCEL (F2 or F3) to cancel storing your Ext. Trig settings. Press YES (F1) to store them.

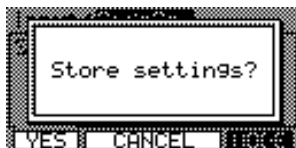

EXT. TRIG MENU

The DM8's Ext. Trig Menu contains several pages of parameters related to triggering (striking pads, cymbals, trigger sensitivity, etc.). The settings in these pages affect **ALL** Kits.

TRIGGER INPUT PARAMETERS

The INP page of the Ext. Trig Menu contains some parameters that affect the triggers' sensivity and function within the module.

1. Press EXT TRIG to enter the main Ext. Trig Menu page. The first page shown should be INP (F1).
2. Select the trigger whose parameters you want to edit by pressing NOTE CHASE then striking the desired trigger. Alternatively, you can highlight the trigger name at the top of the screen using the CURSOR UP / DOWN buttons to highlight it and use the VALUE UP / DOWN buttons or VALUE DIAL to change it.
3. Use CURSOR UP / DOWN to move through the menu items and VALUE UP / DOWN buttons or the VALUE DIAL to adjust the settings:
 - **Sensitivity:** The gain control for the trigger (00-99). The higher the setting, the easier it will be to trigger louder sounds with lighter hits. When setting this parameter, strike the trigger and watch the level meter in the upper-right hand corner of the LCD. If it is "clipping" or maxing out too soon, reduce this setting. The meter should only reach its maximum when you are striking the trigger at your hardest.
 - **Function:** You can assign different functions for the trigger to execute when you strike it:
 - **Trigger:** The associated drum Voice will sound when you strike the trigger.
 - **Next Kit:** The current Kit number will increase by one when you strike the trigger.
 - **Prev Kit:** The current Kit number will decrease by one when you strike the trigger.
 - **Tap Tempo:** The trigger will function as the TAP TEMPO button, entering a new tempo for the sequencer when struck repeatedly.
 - **Seq Play:** Striking the trigger will play the current Sequence.
 - **Seq Stop:** Striking the trigger will stop the currently playing Sequence.
 - **Play/Stop:** The trigger will function alternately as a "play/stop" button for the current Sequence. Striking the trigger once will start playback; striking it during playback will stop the Sequence.
 - **Record:** The trigger will function as a "record" button for the sequencer.
 - **Rec/Stop:** The trigger will function alternately as a "record/stop" button for the sequencer. Striking the trigger once will start recording; striking it during recording will stop it.
 - **InputType:** Select the type of trigger you have connected to the input. Select "PIEZO" for triggers like pads or cymbals. Select "SWITCH" if you are using a drum pad with a rim switch, a cymbal with an edge switch, or a footswitch. (**Note:** This parameter is only seen on certain pages.)
4. When you have finished making your edits, you can press EXIT or any button that will enter another screen (e.g., DRUM KIT, UTILITY, etc. Your edits will remain for that session (i.e., until you turn off the module).

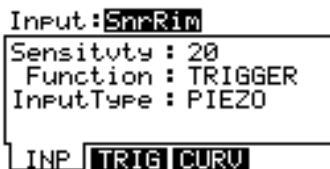

Note: The Utility Menu allows you to set the rough "global" sensitivity of all triggers in the Kit ("Trig Sens"). See the UTILITY MENU chapter for more information.

Note: When assigning a function other than "Trigger," be sure that the physical (hardware) trigger is placed in such a way that it will not receive "crosstalk" or otherwise accidentally trigger as you perform.

TRIGGERING PARAMETERS

The TRIG page of the Ext. Trig Menu contains some parameters that affect the triggers' sensitivity and function within the module.

1. Press EXT TRIG to enter the main Ext. Trig Menu page. Press TRIG (F2).
2. Select the trigger whose parameters you want to edit by pressing NOTE CHASE then striking the desired trigger. Alternatively, you can highlight the trigger name at the top of the screen using the CURSOR UP / DOWN buttons to highlight it and use the VALUE UP / DOWN buttons or VALUE DIAL to change it.
3. Use CURSOR UP / DOWN to move through the menu items and VALUE UP / DOWN buttons or the VALUE DIAL to adjust the settings:

```
Input: SnrHd
Xtalk Rcv : 07
Xtalk Snd : 00
ReTrigger : 04
Threshold : 03
INP TRIG CURV
```

```
Input: SnrRim
Xtalk Rcv : 07
Xtalk Snd : 00
ZoneXtalk : 00
INP TRIG CURV
```

- **Xtalk Rcv *** : How susceptible the trigger is to "crosstalk" from other triggers (00-07). The higher the value, the less likely crosstalk from other triggers will affect it.
 - **Xtalk Snd *** : How likely the trigger will cause "crosstalk" in other triggers (00-07). The higher the value, the less likely it will be a source of crosstalk on other triggers.
 - **Retrigger**: How quickly the module processes repeated strikes of the same trigger (00-99). This is the minimum amount of time needed between successive strikes of the same trigger for the second one to produce a sound. (For instance, if your Retrigger setting is 50 and you strike the trigger once, it will produce a sound if the next strike is at least 50 milliseconds later. Otherwise, it will be silent.) (**Note:** This parameter is only seen on certain pages since it already affects both zones of a drum pad or cymbal that "share" the same TRIGGER INPUT.)
 - **Threshold**: How much velocity (force) is required for a Voice to sound (00-99). At lower settings, very light strikes of the triggers will produce sounds. At higher settings, you will need to strike the triggers harder to produce a sound. (**Note:** This parameter is only seen on certain pages since it already affects both zones of a drum pad or cymbal that "share" the same TRIGGER INPUT.)
 - **ZoneXTalk**: This setting adjusts how susceptible triggers on a "shared" input (e.g., the bell and bow of a ride cymbal, or the head and rim of a the same drum pad) are to "crosstalk" from each other. The higher the setting, the less likely these trigger pairs will cause each other to trigger unintentionally. (**Note:** We recommend increasing this setting for drum pads on which you want to produce "rimshots" by striking the head and rim simultaneously.)
4. When you have finished making your edits, you can press EXIT or any button that will enter another screen (e.g., DRUM KIT, UTILITY, etc. Your edits will remain for that session (i.e., until you turn off the module).

* A note about crosstalk:

"Crosstalk" occurs when a trigger is struck and the vibration from that strike is also "read" as a strike by an adjacent trigger. For instance, if you strike the snare drum hard enough, it is possible for the crash cymbal to sense the vibration of your hit (especially if they are mounted on the same rack) and trigger as well. This unintentional triggering can be reduced or eliminated by adjusting the DM8 module's crosstalk ("Xtalk") settings.

- When you increase a trigger's "Xtalk Rcv" ("Crosstalk Receive") setting, you are making that trigger less susceptible to crosstalk from other triggers' vibrations.
- When you increase a trigger's "Xtalk Snd" ("Crosstalk Send") setting, you are making that trigger less likely to be interpreted by the module as a cause of crosstalk.

In a general sense, these two settings essentially do the same thing: reduce crosstalk. However, there are cases where adjusting one is better than adjusting the other:

Example:

While playing, if you find the first tom is unintentionally triggering as you play heavily on the snare drum, you should increase the first tom's "Xtalk Rcv" setting to reduce its sensitivity to strikes on the snare drum (as well as other triggers).

On the other hand, if you find playing heavily on the snare drum is unintentionally causing several triggers to sound, you should increase the snare drum's "Xtalk Snd" setting so the module interprets vibrations from the snare drum more strictly to reduce errant triggering on the rest of the kit.

VELOCITY CURVE

The CURV page lets you set the velocity curve for the triggers, which determines how a sound's volume is affected by how hard you strike it – that is, how responsive the triggers' dynamics are to changes in your playing.

1. Press EXT TRIG to enter the main Ext. Trig Menu page. Press TRIG (F2).
2. Select the trigger whose parameters you want to edit by pressing NOTE CHASE then striking the desired trigger. Alternatively, you can highlight the trigger name at the top of the screen using the CURSOR UP / DOWN buttons to highlight it and use the VALUE UP / DOWN buttons or VALUE DIAL to change it.
3. Use CURSOR UP / DOWN to move through the menu items and VALUE UP / DOWN buttons or the VALUE DIAL to adjust the settings:
 - **Linear:** The triggers will be consistently responsive to changes in your playing, increasing at the same rate as the force of your hits.
 - **Log 1-4:** The triggers will be more responsive to changes in your playing at lower velocities and become less responsive at higher velocities.
 - **Exp 1-4:** The triggers will be more responsive to changes in your playing at higher velocities and become less responsive at lower velocities.
 - **Spline 1-4:** The triggers will be more responsive to changes in your playing at lower and higher velocities and less responsive at moderate velocities.
 - **Offset:** The triggers will be consistently responsive to changes in your playing at lower and medium velocities and play sounds at the maximum volume at high velocities.
 - **Constant:** The triggers will play sounds at the maximum volume regardless of how hard or soft you hit them.
4. When you have finished making your edits, you can press EXIT or any button that will enter another screen (e.g., DRUM KIT, UTILITY, etc.). Your edits will remain for that session (i.e., until you turn off the module).

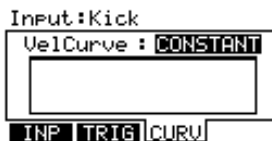
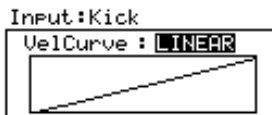

MODE (RIDE BOW & BELL)

You should adjust this setting for the kind of ride cymbal you are using – a dual-zone ride (which has bow and bell triggers) or a three-zone ride (which has edge, bow, and bell triggers).

To do this:

1. Press EXT TRIG to enter the main Ext. Trig Menu page.
2. Select the ride's bow or bell by pressing NOTE CHASE then striking that zone on your cymbal trigger. Alternatively, you can highlight the trigger name at the top of the screen using the CURSOR UP / DOWN buttons to highlight it and use the VALUE UP / DOWN buttons or VALUE DIAL to select either "RideBell" or "RideBow."
3. Press MODE (F4).
4. Use VALUE UP / DOWN buttons or the VALUE DIAL to select "2 Zones" if your ride cymbal is a dual-zone or "3 Zones" if your ride cymbal is a three-zone.
5. When you have finished making your edits, you can press EXIT or any button that will enter another screen (e.g., DRUM KIT, UTILITY, etc.). Your edits will remain for that session (i.e., until you turn off the module).

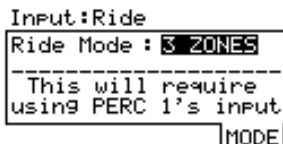

HI-HAT CALIBRATION

The first time you connect a hi-hat pedal to the DM8 module, we recommend calibrating it so the module can "read" the pedal's movement optimally. If you use the same hi-hat each session (even if you have disconnected and reconnected it), then you shouldn't need to calibrate each time as long as you store your trigger settings after calibrating (see STORING TRIGGER SETTINGS in the STORING & COPYING chapter for more information). However, anytime you connect a different hi-hat from the previously connected one, you should calibrate it.

Note: The module's HI-HAT CONTROL TRIGGER INPUT does not support keyboard-style expression pedals.

To calibrate the hi-hat pedal:

1. Connect the hi-hat pedal to the module but do not press it down.
2. On the module, press EXT TRIG.
3. Use the CURSOR UP / DOWN buttons to highlight the "Input" field at the top of the screen then use the VALUE UP / DOWN buttons or VALUE DIAL to select "HiHat."
4. Press CAL (F1).
5. With the hi-hat pedal completely raised ("open"), press OPEN (F1) and wait for a message saying the process is complete.
6. With the hi-hat pedal completely pressed ("closed"), press CLOS (F2) and wait for a message saying the process is complete.
7. If you want to fine-tune how the module detects your pedal's "open" and "closed" positions, press TRIM (F3). Use the CURSOR UP / DOWN buttons to select "Open" or "Closed" and use the VALUE UP / DOWN buttons or VALUE DIAL to adjust the setting. (**Tip:** Increasing the "Closed" value makes it easier to close the hi-hat or "choke" it.)
8. If you want to adjust the response curve of the pedal, press CURV (F4). Use the VALUE UP / DOWN buttons or VALUE DIAL to select the curve that best suits your playing style. (**Tip:** We recommend using LINEAR, LOG1 or LOG2 for conventional hi-hat performance.)
9. When you have adjusted the hi-hat settings to your preference, press EXIT to exit the calibration page (or press DRUM KIT to return to the main screen).

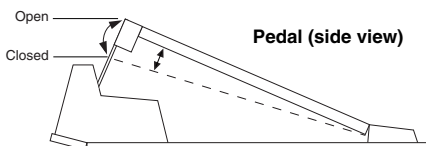

STORING EXT. TRIG SETTINGS

Any changes you make to the parameters in the Ext. Trig Menu will remain for the current session but will return to their defaults if you turn off the module. We recommend storing your settings when you change them so you can use them in future sessions.

To store Ext. Trig settings:

1. Be sure you are in the Ext. Trig Menu by pressing EXT TRIG.
2. Press STORE.
3. A window will appear asking you to confirm your choice. Press CANCEL (F2 or F3) to cancel storing your Ext. Trig settings. Press YES (F1) to store them.



EXPLORING OPTIMAL SENSITIVITY AND THRESHOLD SETTINGS

We created the DM8 module's default settings to allow for great playability right out of the box, but we recommend experimenting with different triggers settings – particularly sensitivity and threshold – so you can find the settings that best suit your playing style. Here is one recommended way to explore these settings:

1. Press EXT. TRIG to access the trigger settings.
2. Make sure NOTE CHASE is activated (the LED should be lit).
3. Strike a trigger on your electronic drum kit whose settings you want to adjust. The name of the trigger will be displayed at the top of the module's LCD.
4. On the INP page, adjust the "Sensitivity" setting to an appropriate level as you strike the trigger with moderate force, typical of how you play. The resulting sound should be neither too loud nor too quiet. (Make sure the "Function" setting is set to "TRIGGER.") If the level meter in the upper-right hand corner is "clipping" or maxing out too soon, reduce the sensitivity.
5. On the TRIG page, adjust the "Threshold" setting to an appropriate level as you strike the trigger as *lightly* as you would while playing. You can use the level meter in the upper right-hand corner of the module's LCD to see whether the module is detecting your hits.
6. After setting the threshold, return to the INP page and readjust the "Sensitivity" setting as you strike the trigger with varying force.
7. Repeat this process for other triggers in your electronic drum kit.
8. Press STORE to save these changes.

Note that you can also adjust the velocity curve for each trigger, which can help in the "shaping" of the triggers' volume levels relative to the range of force you use while playing. Also, the Utility Menu allows you to set the rough "global" sensitivity of all triggers in the Kit. ("Trig Sens") See the UTILITY MENU chapter for more information.

UTILITY MENU

The DM8's Utility Menu contains several pages of parameters that affect the module's overall operation as well as system-related information and functions.

GENERAL

The main page of the Utility Menu contains some global parameters that affect the kit as well as the module itself.

1. Press UTILITY to enter the main Utility Menu page.
2. Use CURSOR UP / DOWN to move through the menu items and VALUE UP / DOWN or the VALUE DIAL to adjust the settings:
 - **Tempo:** Indicates how the module determines tempo from pattern to pattern. When set to "PATTERN," each Pattern will have its own tempo (i.e., the tempo can change when moving from one Pattern to the next). When set to "GLOBAL," the module will follow a fixed, global tempo, ignoring the tempo specific to a pattern.
 - **Acc Pitch:** The tuning of the module's Accompaniment. The default is a standard "A=440Hz." The available tuning range is 430 – 450 Hz.
 - **Contrast:** The contrast of the LCD (0-99).



METRONOME (F1)

Pressing MTRO (F1) from the main Utility Menu lets you access pages that contains the settings for the module's metronome.

MEASURE (F1)

This page controls the sound and level settings of the module's metronome.

1. Press UTILITY to enter the main Utility Menu.
2. Press MTRO (F1) to access the metronome settings. The first page to appear will be MEAS (F1).
3. Use CURSOR UP / DOWN to move through the menu items and VALUE UP / DOWN or the VALUE DIAL to adjust the settings:
 - **MeasLvl:** The volume level of the first metronome beat of every measure (00-99). (The first beat is often louder than the others to mark the beginning of each bar.)
 - **MeasSound:** The sound of the first metronome beat of every measure. (The first beat is often at a slightly higher pitch than the others to mark the beginning of each bar.)
 - **BeatLevel:** The volume level of the overall metronome beat (00-99).
 - **BeatSound:** The sound of the metronome beat.

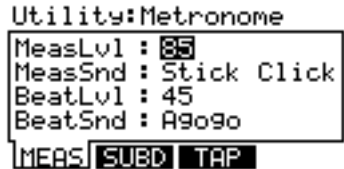

SUBDIVISION (F2)

This page lets you adjust settings for the subdivision metronome. This is similar to the regular metronome but while the regular metronome sounds every beat, the subdivision metronome sounds during smaller intervals of each measure.

1. Press UTILITY to enter the main Utility Menu.
2. Press MTRO (F1) to access the metronome settings.
3. Press SUBD (F2) to access the subdivision metronome settings.
4. Use CURSOR UP / DOWN to move through the menu items and VALUE UP / DOWN or the VALUE DIAL to adjust the settings:
 - **SubDvsn:** The length of each subdivision. The range includes 1/2, 1/4, 1/8, and 1/16 notes – both regular and triplet. (**Example:** If the regular metronome is set to a 4/4 time signature and "SubDvsn" is set to "1/8," you will hear the regular metronome on every 1/4 note as well as the subdivision metronome on every 1/8 note.)
 - **SubDLvl:** The volume level of the subdivision metronome sound (00-99). We recommend keeping this volume relatively low so it is not confused with the regular metronome sound.
 - **SubDSnd:** The sound of the subdivision metronome.

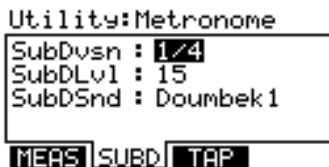

TAP TEMPO (F3)

This page lets you adjust settings for the TAP TEMPO button and the tempo LED.

1. Press UTILITY to enter the main Utility Menu.
2. Press MTRO (F1) to access the metronome settings.
3. Press TAP (F3) to access the Tap Tempo settings.
4. Use CURSOR UP / DOWN to move through the menu items and VALUE UP / DOWN or the VALUE DIAL to adjust the settings:
 - **Tempo LED:** This setting lets you control when the tempo LED will be seen. When set to "ON," the tempo LED will flash all the time. When set to "PAT ONLY," the tempo LED will only flash when a Sequence is playing. When set to "OFF," the tempo LED will never be seen.
 - **Tap Tempo:** Enables or disables the TAP TEMPO button. Disabling it may be useful if you do not want to make any unintentional changes to a Sequence's tempo.



MIDI (F2)

Pressing MIDI (F2) from the Main Utility menu lets you access pages that contains the module's MIDI settings.

INPT (F1)

This page controls the module's MIDI input settings.

1. Press UTILITY to enter the main Utility Menu.
2. Press MIDI (F2) to access the MIDI settings. The first page to appear will be INPT (F1).
3. Use CURSOR UP / DOWN to move through the menu items and VALUE UP / DOWN or the VALUE DIAL to adjust the settings:
 - **Drum Chan:** The MIDI channel number over which the drum sounds will be received (01-16 or "OMNI," which sends it over *all* 16 channels) when played by an external MIDI device.
 - **Acc Chan:** The MIDI channel number over which the Accompaniment will be received (01-16 or "OMNI," which sends it over *all* 16 channels) when played by an external MIDI device.
 - **LocalCont:** This "Local Control" setting determines whether the module receives MIDI messages from the triggers or an external source. When set to "ON" (the default), the module's sounds will receive MIDI messages from your connected triggers. Switch this setting to "OFF" when you are using an external MIDI sequencer. (When using an external sequencer, if this setting is "ON," each note will be triggered twice – once in the module and once via the external sequencer. Turning Local Control "OFF" ensures you will hear the triggered note only once.)

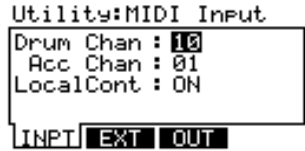

EXT (F2)

This page's settings determine how the module responds to external MIDI controllers.

1. Press UTILITY to enter the main Utility Menu.
2. Press MIDI (F2) to access the MIDI settings.
3. Press EXT (F2) to access the external MIDI settings.
4. Use CURSOR UP / DOWN to move through the menu items and VALUE UP / DOWN or the VALUE DIAL to adjust the settings:
 - **Prog Chng:** Determines if the module will recognize Program Change messages from external MIDI sources. When set to "OFF" (the default), the module will ignore Program Change messages. When set to "RECEIVE," Kits can be selected via Program Change messages from external sources.
 - **Clock In:** Determines if the module will sync to an external MIDI clock. When set to "OFF" (the default), the module will run off its internal clock. When set to "RECEIVE," the module's clock will sync to the "master" clock of a connected external MIDI source.



OUT (F3)

This page controls the module's MIDI output settings.

1. Press UTILITY to enter the main Utility Menu.
2. Press MIDI (F2) to access the MIDI settings.
3. Press OUT (F3) to access the MIDI output settings.
4. Use CURSOR UP / DOWN to move through the menu items and VALUE UP / DOWN or the VALUE DIAL to adjust the settings:
 - **Prog Chng:** Determines if the module will send out Program Change messages to an external USB-MIDI device. When set to "NOT SENT" (the default), the module will not send any Program Change messages. When set to "SENT," the module will send Program Change messages to a connected USB-MIDI device.
 - **Clock Out:** Determines if the module's internal clock will serve as the "master" clock for a connected USB-MIDI device. When set to "NOT SENT" (the default), the module will not send out any MIDI clock information to a connected device. When set to "SENT," a connected USB-MIDI device will sync to the module's internal clock.
 - **MIDI Thru:** When set to "ENABLED" (the default), the module's USB port functions as a MIDI THRU. In this case, a device connected to the module's MIDI IN can send data through the module to a device connected to the module's USB port. When set to "OFF," the module's USB port functions only as a MIDI output for the module itself.



TRIG (F3)

Pressing TRIG (F3) from the Main Utility menu lets you access a page that contains the various trigger settings for the module.

TRIG

1. Press UTILITY to enter the main Utility Menu.
2. Press TRIG (F3) to access the trigger settings.
3. Use VALUE UP / DOWN or the VALUE DIAL to adjust the settings:
 - a. **Trig Sens:** The sensitivity of all the connected triggers – "LOW," "MEDIUM," or "HIGH." Adjusting this setting lets you roughly set the sensitivity of the entire Kit but conveniently keeps the proportions of your individual trigger settings. (To adjust the sensitivity of individual triggers, see the TRIGGER INPUT PARAMETERS section of the EXT. TRIG MENU chapter.)
 - b. **HiHat * :** Select "NOTE+CC#4" or "NOTE ONLY." This determines whether the hi-hat MIDI note will be sent with or without CC information (CC#4).
 - c. **HH Splash * :** Select "SENT" or "NOT SENT." This determines whether the hi-hat "splash" note (generated by quickly pressing then releasing the pedal) will be sent or not.
 - d. **Cym Choke * :** Select "SENT" or "NOT SENT." This determines whether the cymbal "choke" note (generated by grabbing the cymbal and touching the choke strip) will be sent or not.

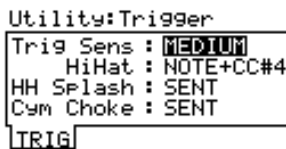

** Note: The "HiHat," "HH Splash," and "Cym Choke" parameters allow you to tailor the MIDI output of these notes, which is useful when using the module with an external hardware or software drum module that does not support a variable hi-hat pedal, the hi-hat "splash," cymbal choking, etc. Also, even when these parameters are set to "NOTE ONLY" or "NOT SENT," the MIDI notes and information you have "disabled" will actually still be recorded when you record a Sequence, but they will not be sent to the MIDI output.*

SYS (F4)

Pressing SYS (F4) from the Main Utility menu lets you access a page that contains the module's various system settings.

SYSX (F1)

This page lets you send out the module's settings as a SysEx (.syx) file to be recalled later.

1. Press UTILITY to enter the main Utility Menu.1)
2. Use CURSOR UP / DOWN to move through the menu items:
 - a. **All Memory:** All of the module's memory that can be saved will be saved as a SysEx file. This includes your trigger settings, Kits, and Sequences.
 - b. **All Trigger Settings:** Only the module's trigger settings will be saved as a SysEx file.
3. Press SEND (F4) to send the selected settings from the module as a SysEx file.

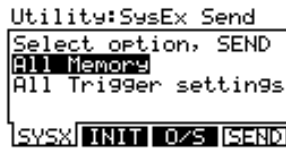

INIT (F2)

This page lets you reinitialize different settings in the module, restoring them to their factory defaults.

1. Press UTILITY to enter the main Utility Menu.
2. Press SYS (F4) to access the Accompaniment settings.
3. Press INIT (F2) to access the reinitialization page.
4. Use CURSOR UP / DOWN to move through the menu items:
 - a. **All Kits:** All of the module's Kits and their settings will return to their factory defaults.
 - b. **All Sequences:** All of the module's Sequences and their settings will return to their factory defaults.
 - c. **All Trigger Settings:** All of the module's trigger settings will return to their factory defaults.
5. Press EXEC (F4).
6. A window will appear asking you to confirm your choice. To confirm and reinitialize the selected settings, press YES (F1). To cancel, press CANCEL (F2 or F3).

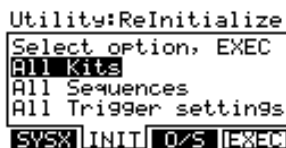

O/S (F3)

This page contains information about the module's current operating systems and sound ROM.

1. Press UTILITY to enter the main Utility Menu.
2. Press SYS (F4) to access the Accompaniment settings.
3. Press O/S (F3) to access the operating system information page.
4. This page contains the version numbers of the module's current software:
 - a. **Trig OS:** The current version number of the trigger firmware.
 - b. **Sound ROM:** The current version number of the sound ROM – the library of sounds read by the module.
 - c. **Sound OS:** The current version number of the module's own firmware.

Utility:O/S

```

Trig OS : V1.00
Sound ROM : V1.00
Sound OS : V1.00
  
```

SYSX INIT O/S MEM

Note: Be sure to register your DM8 module at www.alesis.com to be notified if new software becomes available.

MEM (F4)

This page contains information about the module's available memory and lets you enable or disable write protection.

Note: There are no editable parameters on this page.

1. Press UTILITY to enter the main Utility Menu.
2. Press SYS (F4) to access the Accompaniment settings.
3. Press INIT (F2) or O/S (F3) to change the available F-BUTTON tabs. MEM (F4) will become available.
4. Press MEM (F4) to access the memory page.
5. This page contains two items:
 - a. **Memory:** The amount of currently available module memory.
 - b. **WriteProt:** Use the VALUE UP / DOWN buttons or VALUE DIAL to enable or disable write protection. When set to "ON" (the default), you can make changes to the Kits, Instruments, Sequences, etc., but will not be able to store them. When set to "OFF," you can store these settings.

Utility:Memory

```

Memory : 99% FREE
WriteProt : OFF
  
```

SYSX INIT O/S MEM

UPDATING THE MODULE

To update the module, follow these steps:

1. If you have not done so already, download the updater application from www.alesis.com/dm8 (under the "Docs & Downloads" tab.)
2. Connect the module's USB port to your computer with a standard USB cable.
3. Press and hold the module's REC button while turning it on. (**Windows users:** If you see a message that says Windows was unable to install a driver, ignore it.)
4. Open the DM8 Updater application.
5. **Windows users:** Select "USB Audio Device" (the DM8 module) from the "MIDI Interface" dropdown menu.
Mac users: The DM8 module will be automatically selected.
6. Drag the appropriate file onto the application, or click "File" then "Open" and select the file. You can upload SysEx (.sxx) files – such as sound ROM files or firmware files – in this fashion.

Note: Third party sound ROMs are also considered updates and can be loaded to the DM8 module in this fashion.

Note: If you encounter an error message while switching on the module, it is possible the sound ROM cannot be read correctly. In this case, reload the sound ROM file and try again.

Note: Since the release of this module, we may have released new firmware or sound ROM files. To keep your module current, we recommend checking the "Docs & Downloads" tab of www.alesis.com/dm8 for available updates for your DM8 module.

MIDI SETUP

You can use the DM8 module as a trigger-to-MIDI interface, allowing you to use your electronic drum kit to trigger sounds from external sound libraries. This means you can use your hardware kit to play sounds in software drum modules like BFD, Toontrack, Reason, and many others.

You can also use external MIDI devices – such as MPCs, the Alesis ControlPad or PerformancePad, or other MIDI controllers – to trigger sounds from the DM8's own extensive sound library instead of (or in addition to) the electronic drum kit.

To use the DM8 in these ways, you will need to set it up to communicate with your external device(s) via MIDI. Here are a couple examples of how to do this.

Using the DM8 to trigger sounds from a software drum module:

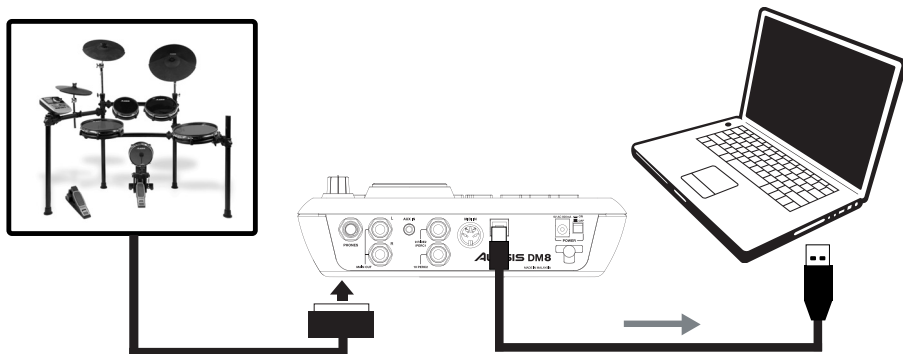

1. Connect the module's USB port to your computer with a standard USB cable.
2. Press UTILITY to access the module's Utility Menu.
3. Press MIDI (F2) to access the MIDI settings.
4. Press OUT (F3) to access the MIDI output settings.
5. Use CURSOR UP / DOWN to move through the menu items and VALUE UP / DOWN or the VALUE DIAL to adjust the settings accordingly:
 - a. **Prog Chng:** "SENT" (so the DM8 can send Program Change messages to the software).
 - b. **Clock Out:** "SENT" (if you want the DM8's MIDI clock to be the "master" clock) or "NOT SENT" (if you do not want the DM8 to send out MIDI clock information).
 - c. **MIDI Thru:** "OFF."
6. Set your software to receive MIDI messages from the DM8 module ("USB Audio Device"). Consult your software's manual for more information.

***Note:** These are just recommended settings. You may configure the DM8's MIDI settings however best suits your performance needs. See the MIDI section of the UTILITY MENU chapter and the DRUM KIT SETUP section of the KITS, VOICES, ACCOMPANIMENT & INSTRUMENTS chapter for more information.*

Using an external MIDI device with the DM8's sound library:

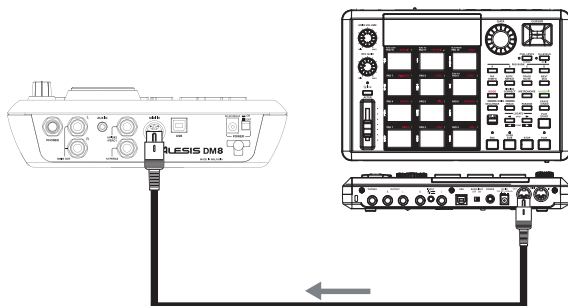

1. Connect the DM8's MIDI IN port to your external device's MIDI OUT port using a standard MIDI cable.
2. Press UTILITY to access the module's Utility Menu.
3. Press MIDI (F2) to access the MIDI settings.
4. Press INPT (F1) to access the MIDI input settings.
5. Use CURSOR UP / DOWN to move through the menu items and VALUE UP / DOWN or the VALUE DIAL to adjust the settings accordingly:
 - a. **Drum Chan:** Set this to the MIDI channel (01-16 or "OMNI") over which the drum sounds will be received when played by your external device.
 - b. **Acc Chan:** Set this to the MIDI channel (01-16 or "OMNI") over which the Accompaniment sounds will be received when played by your external device.
 - c. **LocalCont:** "OFF" (otherwise, each note you trigger will be heard twice)
6. Press EXT (F2) to set how the DM8 will respond to the external device.
7. Use CURSOR UP / DOWN to move through the menu items and VALUE UP / DOWN or the VALUE DIAL to adjust the settings accordingly:
 - a. **Prog Chng:** "RECEIVE" (so the DM8's Kits can be selected via Program Change messages from the external device).
 - b. **Clock In:** "OFF" (if you want the DM8 to run off its own internal clock) or "RECEIVE" (if you want to sync the DM8's clock to the clock of your external device).
8. Set your external device's settings to send MIDI to the DM8 module. Consult your software's manual for more information.

***Note:** These are just recommended settings. You may configure the DM8's MIDI settings however best suits your performance needs. See the MIDI section of the UTILITY MENU chapter and the DRUM KIT SETUP section of the KITS, VOICES, ACCOMPANIMENT & INSTRUMENTS chapter for more information.*

RESTORING BACKUP SYSEX FILES

To load a backup SysEx file to the module from your computer, follow these steps:

1. With the module off, connect the module's USB port to your computer with a standard USB cable.
2. Press and hold the module's STORE button and turn it on. The LCD should display, "MIDI RESTORE Waiting..." This means it is ready to receive a SysEx file from your computer.
3. Use a MIDI utility to send the appropriate SysEx file to the module (which will need to be selected as the receiving MIDI device). We recommend the following utilities:
 - MIDI-OX (PC): <http://www.midiox.com>
 - SysEx Librarian (Mac): <http://www.snoize.com/SysExLibrarian/>
4. The LCD will indicate when the process is complete. Once it is complete, restart the module.

MIDI IMPLEMENTATION CHART

	Transmit/Export	Recognize/Import	Remarks
<i>1. Basic Information</i>			
MIDI channels	1-16	1-16	Drums: 10 (default) Accomp: 1 (default)
Note numbers	0-127	Drums: 28-91 Accomp: 0-127	
Program change	0-99	0-99*	*Used for selecting active kit
Bank Select response?	Yes	Yes*	*0: Kits 0-99, 1: Kits 100-199
Modes supported: Mode 1: Omni-On, Poly Mode 2: Omni-On, Mono Mode 3: Omni-Off, Poly Mode 4: Omni-Off, Mono Multi Mode	Yes Yes Yes Yes Yes	Yes Yes Yes Yes Yes	
Note-On Velocity	Yes	Yes	
Note-Off Velocity	No	No	
Channel Aftertouch	No	No	
Poly (Key) Aftertouch	No	No	
Pitch Bend	Yes	Yes	For Basses Only
Active Sensing	No	No	
System Reset	No	No	
Tune Request	No	No	
Universal System Exclusive	No	No	
Manufacturer or Non-Commercial System Exclusive	Yes	Yes	Used for backup / restore and loading new sound sets
NRPns	No	Yes	See MIDI Implementation Supplement
RPNs	No	No	
<i>2. MIDI Timing and Synchronization</i>			
MIDI Clock	Yes	Yes	
Song Position Pointer	Yes	No	
Song Select	No	No	
Start	Yes	Yes	
Continue	Yes	Yes	
Stop	Yes	Yes	
MIDI Time Code	No	No	
MIDI Machine Control	No	No	
MIDI Show Control	No	No	
<i>3. Extensions Compatibility</i>			
General MIDI compatible?	No	Partial	GM Drum Sounds compatible
DLS compatible?	No	No	
Standard MIDI Files	No	No	
XMF Files	No	No	
SP-MIDI compatible?	No	No	

DM8 KITS

#	Name	#	Name	#	Name
0	Fusion	34	9 OH 9	68	Guitar Jam
1	Big Mellow	35	Flim Flam	69	Techno
2	CableSnare	36	SquareBdge	70	VocalDrums
3	Bop Brush	37	Old SKool	71	Med Room
4	Big Wet	38	Hiss Hop	72	Funky Drmr
5	Clav Jam	39	Nu Jack	73	ConcertTom
6	Wood Pop	40	Pop Brush	74	World 2
7	Dry Rocker	41	PingySnare	75	FunkRinger
8	Big Rocker	42	Mini Me	76	Latin Jazz
9	Crank It	43	Thick Rock	77	12" Funk
10	Trig Samp	44	Levee	78	Fuse Hop
11	Evil Drums	45	Deep Jam	79	ThickBlues
12	Absolute	46	Picc Verb	80	World 3
13	Ballad	47	Slick Jazz	81	Orch Traps
14	Big BackBt	48	Picc Funk	82	Paisley
15	Dry Honk	49	Thick Thin	83	Funk Pop
16	ClassicR&B	50	Indo Ethno	84	Funk Snap
17	Dead Snare	51	Studio	85	80s Stndrd
18	Deep Dish	52	World 1	86	Hi Fusion
19	Rocker Jam	53	FunkBigKik	87	Hi Round
20	JungleVerb	54	RingyMetal	88	Brush Room
21	Deli World	55	Mello Snap	89	Cavern
22	Trash Funk	56	8 OH 8	90	Kick Click
23	Fat Back	57	Trad Hop	91	Funk Bop
24	Africa	58	CountryRok	92	Phi Gospel
25	Latin Set	59	Handrums	93	NoFrontHd
26	NuAge Perc	60	PowerBlues	94	Super Kik
27	Latin Kit	61	Orchestra	95	Samba
28	Keystone	62	Picc Punk	96	Thonk
29	Rnd Latin	63	Reggae	97	Pop Idol
30	Elec Tech	64	Piano Rock	98	Far East
31	Elec Hop	65	Comedy FX	99	World 4
32	Electro	66	Fat Attack		
33	Ethno Tek	67	OG SIM		

DM8 SEQUENCES

#	Name	#	Name	#	Name
0	Jalapeño	25	Med House	50	Funx Rox
1	Slow Metal	26	Industro	51	Jbass Groov
2	Surf Punk	27	Discotron 6	52	Idol Rock
3	70sHardRock	28	Afro-Cuban	53	Dark Rock
4	Texas Blues	29	Mozambesque	54	Punx
5	J-Bon	30	BassGroover	55	Shuff Drive
6	Indie Rock	31	MedSlowBlu	56	Shuffle On
7	Blues Shuff	32	ChaCha	57	Shuff Rock
8	Funk Jazz	33	Up County	58	Funk It
9	BigBand	34	Cntry Swing	59	Surf Rocker
10	Bossa Nova	35	Ethno Tek	60	Round Rock
11	Stanky	36	Jungle	61	16th Rock
12	CountryRock	37	Sneaky Funk	62	Mysterock
13	Jazz Waltz	38	ElectricFsn	63	SD Rock
14	Get Uppa!	39	Blues Swing	64	Energy Rock
15	Fusion 1	40	Jazz Waltz2	65	Surf Pop
16	Hip Hop 1	41	Jazz Waltz3	66	Mover
17	House	42	Log Cabin	67	Picante
18	Urban	43	LateEvening	68	Salsa
19	R&G	44	Mambo	69	Samba 1
20	Nails	45	SOS	70	Samba 2
21	16th Shuffl	46	Slinky Rock	71	Subdivider
22	One Drop	47	Want me?	72	Reggae 1
23	Philly Hop	48	Big Rock	73	Reggae 2
24	Swinger 5	49	Surf Rock	74	World

DM8 INSTRUMENTS

KICKS

70s Rock	FunkPlus	Pop 2
80s Rock	Fusion	Quarter Head
90s Rock	Gr 90s 20"	RockKik
Ambient	Garage	Rocker
Ambient Rock	Growl	Room
Banger	HR16 Rock	Round
Bass N Kick	Hard Head	Round Blues
Big 26"	Hard Rock 1	Single Head
Big Butt	Hard Rock 2	Slap
Big Punch	Hardware	Snare & Kick
Big Smack	High N Tite	Solid 1
Blastbeat	Hmm	Solid 2
Blues 1	Jazz Kick	Solid 3
Blues 2	Jazzy	Splat
Country	Kuma 1	Stage
Crescent	Kuma 2	Standard 22"
Crunch	LD Dmpnd 26"	Studio Kick
Cust Tiny16"	Lo Fi	Thick Head
Deep	Lo N Tite	Thud Head
Double Head	Loose Batter	Thump
Dry	Louie Kick	Thumpy
Dry Bop 18"	Low 24"	Thunk
Dry Room	Lud 60s 22"	Thunky
EastRoom	Metal Head	Tight 20"
Energizer	Modern	Tight Funk
Flabby	Narrow	Tighter 20"
Floppy	Noisy	Tite Room
Funk 1	Piano Rock	Warm
Funk 2	Pillow	Y RecCus 24"
Funk Head	Pop 1	

SNARES

70's Rock	Funk Plus	Piccolo 6
80's Rock	Low Snare 1	Present
90's Rock	Low Snare 2	R5x14DynRS
BL 65x14 Opn	Lu5x14 AcoRS	R5x14DynRdRS
BL 65x14 RS	Lu5x14 AcoRd	R5x14DynStk
Balt6x13	Lu5x14 SBrRS	RK7x14 Damp
Balt6x13 RS	Lu5x14 SBrsh	RK7x14 OpCnt
Balt6x13XStk	Lu5x14 SS	RK7x14 RSDmp
BlastbeatSnr	Lu5x14 SS RS	Ringer
Blues Club	Lu5x14BBDDamp	Round Blues
Bright 1	Lu5x14BBOfCn	Shred RS
Bright 2	Lu5x14BBOpCn	Shred Snare
Brush Jazz	Lu5x14BBRS	Side Snare
Brush JazzRS	Lu5x14BBXStk	Snare Brush
Brush Lite	MarchingBand	Steel
Brush LiteRS	McD6x14Stk	Studio Rim
Brush Snr	McD6x14StkRS	Studio Snare
Brush Snr RS	Meaty	Thin Beauty
Chrome 5x14	P6x14 FFS	Thonk Dry
Clap Snare	P6x14 FFS RS	Tight
CrescentSnr	Pc3x14SnOfRS	Wood Rim
Crisp	Pc3x14SnrOff	Wooden
DB Funk	Philly Funk	Woody 1
Deadwood	Piccolo 1	Woody 2
Deep Snare	Piccolo 2	Y4x14 OffCnt
East Room	Piccolo 3	Y4x14 OpCen
Flanged	Piccolo 4	Y4x14 RS
Full	Piccolo 5	

TOMS

70s 10"	Roto 12" Dn	Temp Mute16"
70s 12"	Roto 12" Up	Temp Mute18"
70s 14"	Roto 14"	Temp Rim
70s 16"	Roto 14" Dn	Y 12x14 MCA
G 14x14	Roto 14" Up	Y 14x16 MCA
G 8x10	Roto 16"	Y 7x8 MCA
G 8x12	Roto 16" Dn	Y 8x10 MCA
G Brsh 14"	Roto 16" Up	Y 9x12 MCA
G Brush 12"	Snr+BrshHi 1	Y Damp 10"
G Damp 10"	Snr+BrshHi 2	Y Damp 8"
G M 14"	Snr+BrshLo 1	Y DampSn 10"
G Mute 10"	Snr+BrshLo 2	Y DampSn 8"
G Mute 12"	Snr+BrshMid	Y Mute 10"
G Mute 13"	StSnare Hi 1	Y Mute 12"
G Mute 16"	StSnare Hi 2	Y Mute 14"
G MuteRim10"	StSnare Lo 1	Y Mute 16"
G MuteSn 10"	StSnare Lo 2	Y Mute 8"
G Rim 12"	StSnare Mid	Y PinStrp10"
G Rim 14"	Temp 10x14	Y PinStrp12"
Lud16x16 60s	Temp 16x16	Y PinStrp14"
Lud9x13 60s	Temp 16x18	Y PinStrp8"
Roto 12"	Temp Mute14"	

HI-HATS

08 HiHat	Heavy 2	Thick
09 HiHat	Hybrid 1	Thin
China Hat	Hybrid 2	Tiny
Chunky	Jazz Hat	VintageElect
Crazy Hat	Lite	Vocal Hat
Electro 1	Orchestral	Z60sNB 15"
Electro 2	Raspy	ZBrush60s14"
Ethnic	SFusion 13"	ZManhatn 14"
Heavy 1	Techno	ZReMix 12"

CRASH

16" Darker	Dark Mallet	Stereo Crash
16" Thin	Dark Splash	Vintage
17" AC Stick	Flange Sizzl	Vocal Crash
17" DarkStik	Flange Cym	Z AC Stk 16"
17" KD Dark	H Xtreme 17"	Z KCon 18"
17" KD Lite	HHX Splash	Z KDrkBsh17"
17" KDBrshLT	Mallet Crash	Z KDrkMlt17"
17" Thin	Raspy Crash	Z Kdark 16"
18" Mallet	S Fierce 16"	Z Kdark 17"
20" Crash	Sizzle	ZCon Splash
Big Crash	Small Crash	ZSplash 10"
Big Mallet	Splashy	
Choke	StFI Crash	

RIDE

B HVCrsh 20"	Flange	Vocal Ride
Big Stick	Glass Ride	Z HVCrsh 20"
BosAntiq 20"	H HvyStk 21"	Z HVCrsh 22"
BosAntiq 22"	H JzBrsh 22"	Z K Thin 22"
China Ride	H MdSizzl18"	Z KHiDef 20"
CrashRid 20"	Jazz Brush	Z KHiDef 22"
Crazy	Large	Z Klstnbl20"
Electro	Mark Tree FX	Z KZ 18"
Ethno	Piatti Ride	Z Kthin 20"
EthnoTekRide	Stub	

CHINA

Big China	Hi China Stk	WChnaRvt 18"
China China	SChnaMal 18"	WSplash
Flange China	SSplash 12"	WSplash 10"
Gong China	WChina 17"	Z Stick 8"

ELECTRC KICK

08 Kick Long	HipHop Kik 4	SDS Kick 2
08 Kick Shrt	HipHop Kik 5	SDS Kick 3
09 Kick Long	HipHop Kik 6	SDS Kick 4
09 Kick Shrt	HipHop Kik 7	Shred Head
EleKick 1	HipHop Kik 8	SolidSDSKik
EleKick 2	Hmm Kik	Tek Kik
HipHop Kik 1	House Kick	Vocal Kik
HipHop Kik 2	SDS Deep Kik	Zap Kick
HipHop Kik 3	SDS Kick 1	

ELECTRC SNR

08 Clap Sn	HipHop Snr 3	SDS08 Snare
08 Snare	HipHop Snr 4	SDS09 Snare
09 Snare	LoFi Snare	Tek Stk
Dance Snare	SDS Crack	Vocal Snare
Grunge Snare	SDS Crak Snr	Vocal SnrRS
HRB Snare	SDS Snare 1	Vox Snare
HipHop Snr 1	SDS Snare 2	
HipHop Snr 2	SDS Snare 3	

ELECTRC TOMS

08 Tom Hi	Hex Tom 1 Hi	Oil Can
08 Tom Lo	Hex Tom 1 Lo	SDS Tom 1
08 Tom Md	Hex Tom 1 Md	SDS Tom 2
09 Tom Hi	Hex Tom 2 Hi	SDS Tom 3
09 Tom Lo	Hex Tom 2 Lo	SDS Tom Hi
09 Tom Md	Hex Tom 2 Md	SDS Tom Lo
Fing Tom Hi	Hex Tom 3 Hi	SDS Tom Md
Fing Tom Lo	Hex Tom 3 Lo	
Fing Tom Md	Hex Tom 3 Md	

ELECTRC PERC

08 Clap	09 Rim	SciFi 2
08 Clave	78 Metal	SciFi 3
08 Conga Hi	C1SynHat	SciFi 4
08 Conga Lo	CITekHat	Shape Noise
08 Conga Md	Mtek Hi Hat	Synth Tamb
08 Cowbell	Op Syn Hit	Tek Hat
08 Cymbal	Robot Snare	Whack
08 Maracas	SciFi 1	

ORCH PERC

Marimba C3	Orch Bass 2	Tympani 1
Marimba C4	Orch Bell	Tympani 2
Marimba G2	Orch Cymbal	Tympani 3
Marimba G3	Orch Snare	Tympani 4
Orch Bass 1	Orch Snr Rim	Xylo

ORIENTAL PERC

Chinese Cym1	Gong	Okedo Taiko
Chinese Cym2	Gong High	Shime Taiko
Chinese Drum	Gong Low	Temple Block
FingerCymbal	HiraTaiko36"	Wood Block
FingrTriangl	HiraTaiko60"	

LATIN PERC

2way Cowbell	Cowbell 2	SmTriangleO
Agogo	Cowbell 3	Stick Click
Agogo Hi	Crasher	Surdo 1
Agogo Lo	Cuica Dn	Surdo 2
Agogo Lo 2	Cuica Up	Syn Shagr
Bead Shaker	Drum Stix	Tamb Mute
BellTree Dn	Guiro 1	Tamb Open
BellTree Up	Guiro 2	Tambourine
Block 1	Low Tamb	TimbaleHi 1
Block 2	LrgTriangleM	TimbaleHi 2
Block Mallet	LrgTriangleO	TimbaleHi 3
BoLanGoo	Maracas	TimbaleHiRim
Bongo HiOpen	NativeAmrcan	TimbaleLo 1
Bongo HiSlap	Paah	TimbaleLo 2
Bongo LoOpen	PandeiroMute	TimbaleLoRim
Bongo LoSlap	PandeiroOpen	TmbourneMte1
Breketa	PandeiroTap	TmbourneMte2
Cabasa 1	Rattle	TmbrmFngrMte
Cabasa 2	Reco Reco	TmbrmFngrOpn
Cast Roll	Shaker 1	TmbrmStckMte
Claves	Shaker 2	TmbrmStckOpn
Conga HiMute	Shaker 3	Triang Mt Hi
Conga HiOpen	Shaker 4	Triang Op Hi
Conga HiSlap	Shaker 5	Triangle Cl
Conga LoMute	Shaker 6	Triangle Op
Conga LoOpen	Shaker Hi	Vibraslap
Conga LoSlap	Shaker Lo	Whistle Long
Cowbell 1	SmTriangleM	Whistle Shrt

ETHNIC PERC

Djembe 1	Steel Pan G3	Tabla Tin 1
Djembe 2	Tabla 1	Tabla Tin 2
Djembe 3	Tabla 2	Tabla Tin 3
Djembe 4	Tabla 3	Talk Drum
Doumbek 1	Tabla 4	Tavil
Doumbek 2	Tabla 5	Udu Hole 1
Doumbek 3	Tabla 6	Udu Hole 2
Ghatam	Tabla Ga	Udu Slap 1
Nagara	Tabla Ka	Udu Slap 2
Steel Pan A3	Tabla Na	Udu SlapHole
Steel Pan E3	Tabla Te	Udu Top

RANDOM

Agogo Rnd	Funk Synth	Lo Timb Rnd
Bongo Rnd	Funky Gtr	Metal GtrSeq
Clavick	Gtr Chunks	Pan Timb
Conga Seq	Gtr Comp	Punk Gtr
Congo Bongo	Hi Conga Rnd	Rock Cmp
CowBell Rnd	Hi Timb Rnd	Scratch Rnd
Deep Gtr	HipHop Voc 1	Shaker Rnd
Djembe Seq	HipHop Voc 2	Timbal Rnd
Funk Gtr 1	Indian Rnd	Udu Seq
Funk Gtr 2	Indo Pan	Zep Gtr
Funk Horns	Lo Conga Rnd	Lo Timb Rnd

BASS

Bass Harm	Jazz Upright	Rattle Bass
Ch Pick	MellowUprght	Rattle VSw
ChrsFretless	Open Jazz	Slap Bass 1
Crunch Bass	Pick Bass 1	Slap Bass 2
Damp Pick	Pick Bass 2	Slap Bass 3
ElectrcBass1	Pick Bass 3	SlapNPop 1
ElectrcBass2	Pick Bass 4	SlapNPop 2
Fretless	Pick Bass 5	Upright Bass

SYNTH BASS

And Mogue	Mini Bass 6	Silver Box
Bassic	Mini Bass 7	Sine Bass
Drum Bass	Mini Bass 8	Snick Attack
ElectrolytCh	Mini Bs1 Ch	Syn Bass 1
Electrolyte	Mini Bs2 Ch	Syn Bass 2
Mazzo	Mini Bs3 Ch	Syn Bs1 Ch
Mini Bass 1	Mini Bs4 Ch	Syn Bs2 Ch
Mini Bass 2	Mini Bs5 Ch	TB Three
Mini Bass 3	Oct Bass	Trance
Mini Bass 4	Pro Phat	
Mini Bass 5	Series 900	

FX/OTHER

Bulb Horn	Ha	Tek Hit 1
Car Crash	Jyeah	Tek Hit 2
Car Skid	Lite Snap	Tek Hit 3
CarHornLong	Muscle 5th	Tek Hit 4
CarHornShort	Power Snap	Tek Hit 5
Dog Bark	Rev Crash	Tek Hit 6
Door Slam	Rev Crash Fl	Tek Hit 7
Duck Call	Rev PicSnare	Thunder
Duck Snort	Rev Ride	Ugh
E Piano	Rev Ride Fl	VocalTom 1
Finger Snap	Rev Snare	VocalTom 2
Flextone	Scratch 1	VocalTom Lo
Fresh	Scratch 2	VocalTom Mid
GM Mod	Scratch 3	Wah Gtr 1
Glass	Scratch 4	Wah Gtr 2
Grunt	Sleigh Bell	Yeah
Gun Shot	Slo Yeh	
HR Snap	Stereo Clap	

HIT GROUPS

5-4 Jazz	All Vibes Lo	Indie Rock
70sHardRock	All Xylophne	J-Bon
All AcGuitar	Blues Shuffl	Jalapeño
All CleanGtr	Bossa Nova	Jazz
All EPs	Country Gtrs	Jazz Waltz
All HeavyGtr	Funk 8	Punk
All Horns	Funk Jazz	RnB 5
All MarimbaH	Fusion 1	Slow Metal
All MarimbaL	Get Uppa!	Stanky
All OrchBell	Hip Hop 1	Strait Blues
All Slides	Hip Hop 2	Urban
All SteelDrm	House 1	
All Vibes Hi	House 2	

HITS

70sHR Gtr 1	C El Gtr 03	HipHp1 Gtr05
70sHR Gtr 2	C El Gtr 04	HipHp1 Gtr06
70sHR Gtr 3	C El Gtr 05	HipHp1 Gtr07
70sHRcombo 1	C El Gtr 06	HipHp1 Gtr08
70sHRcombo 2	C El Gtr 07	HipHp1 Gtr09
70sHRcombo 3	FJ EP 01	HipHp1 Gtr10
70sHRcombo 4	FJ EP 02	HipHp1 Gtr11
70sHRcombo 5	FJ EP 03	HipHp1 Gtr12
70sHRcombo 6	FJ EP 04	HipHp1 Gtr13
A Gtr Chk 1	FJ EP 05	HipHp1 Gtr14
A Gtr Chk 2	FJ EP 06	HipHp1 Gtr15
A Gtr Chk 3	FJ EP 07	HipHp1 Gtr16
A Gtr Chk 4	FJ Guitar 01	HipHp1 Gtr17
A Pwr Gtr 1	FJ Guitar 02	HipHp1 Syn01
A Pwr Gtr 2	FJ Guitar 03	HipHp1 Syn02
A Pwr Gtr 3	FJ Guitar 04	HipHp1 Syn03
A Pwr Gtr 4	FJ Guitar 05	HipHp1 Syn04
A Pwr Gtr 5	FJ Guitar 06	HipHp1 Vox01
A Pwr Gtr 6	FJ Guitar 07	HipHp1 Vox02
Bass Slide 1	FJ Guitar 08	HipHp1 Vox03
Bass Slide 2	FJ Guitar 09	HipHp1 Vox04
Bass Slide 3	FJ Guitar 10	HipHp1 Vox05
Bass Slide 4	Fusion Gtr 1	HipHp1 Vox06
Bass Slide 5	Fusion Gtr 2	House EP 1
Bass Slide 6	Fusion Gtr 3	House EP 2
Bass Slide 7	Fusion Gtr 4	House EP 3
Blues Gtr 01	Fusion Gtr 5	House EP 4
Blues Gtr 02	Fusion Gtr 6	House EP 5
Blues Gtr 03	Fusion Gtr 7	House Gtr 1
Blues Gtr 04	Fusion Gtr 8	House Gtr 2
Blues Gtr 05	Fusion Gtr 9	House Gtr 3
Blues Gtr 06	FusnEP Amin	House Gtr 4
Blues Gtr 07	FusnEP BbMaj	House Gtr 5
Blues Gtr 08	FusnEP Bmin	House Gtr 6
Blues Gtr 09	FusnHrn4th1	House Syn 1
Blues Gtr 10	FusnHrn4th2	House Syn 2
Blues Gtr 11	FusnHrn4th3	House Syn 3
Blues Gtr 12	FusnHrn4th4	J-Bon Gtr 1
BosNovaEP 01	FusnHrnMn3d	J-Bon Gtr 2
BosNovaEP 02	FusnHrnOctB	J-Bon Gtr 3
BosNovaEP 03	FusnHrnOctBb	J-Bon Gtr 4
BosNovaEP 04	FusnHrnOctC	J-Bon Gtr 5
BosNovaEP 05	FusnHrnOctD1	J-Bon Gtr 6
BosNovaEP 06	FusnHrnOctD2	J-Bon Gtr 7
BosNovaEP 07	FusnHrnOctF	JW Vibes A2
BosNovaEP 08	FusnHrnOctF#	JW Vibes Ab2
BosNovaEP 09	FusnHrnOctG	JW Vibes Ab3
BosNovaEP 10	GetUppalGtr1	JW Vibes Bb2
BosNovaEP 11	GetUppalGtr2	JW Vibes Bb3
BosNovaEP 12	GetUppalGtr3	JW Vibes C3
BosNovaEP 13	GetUppalGtr4	JW Vibes D3
BosNovaEP 14	GetUppalGtr5	JW Vibes Eb3
C Ac Gtr 01	GetUppalGtr6	JW Vibes F3
C Ac Gtr 02	GetUppalGtr7	JW Vibes G2
C Ac Gtr 03	GetUppalGtr8	JW Vibes G3
C Ac Gtr 04	GetUppalOrg1	Jal Gtr 01
C Ac Gtr 05	GetUppalOrg2	Jal Gtr 02
C Ac Gtr 06	GetUppalOrg3	Jal Gtr 03
C Ac Gtr 07	GetUppalOrg4	Jal Gtr 04
C Ac Gtr 08	GetUppalOrg5	Jal Gtr 05
C Ac Gtr 09	GetUppalOrg6	Jal Gtr 06
C Ac Gtr 10	HipHp1 Gtr01	Jal Gtr 07
C Ac Gtr 11	HipHp1 Gtr02	Jal Gtr 08
C El Gtr 01	HipHp1 Gtr03	Jz GtHn EbM7
C El Gtr 02	HipHp1 Gtr04	Jz GtHn Emin

HITS (cont.)

Jz GtHn F#m	R&G VSyn 1	SM Gtr 15
Jz GtHn FMj7	R&G VSyn 2	StankyClav 1
Jz GtrHrn A	R&G VSyn 3	StankyClav 2
Jz GtrHrn Bb	R&G VSyn 4	StankyClav 3
Jz GtrHrn C	R&G VSyn 5	StankyClav 4
Jz GtrHrn D	R&G Vox 1	StankyClav 5
Jz GtrHrn E	R&G Vox 2	StankyGtr 01
Jz GtrHrn Eb	R&G Vox 3	StankyGtr 02
Jz GtrHrn F	SB Gtr Fx 01	StankyGtr 03
Jz GtrHrn G1	SB Gtr Fx 02	StankyGtr 04
Jz GtrHrn G2	SB Gtr Fx 03	StankyGtr 05
Jz Pno BassC	SB Gtr Fx 04	StankyGtr 06
Jz Pno BbMj7	SB Gtr Fx 05	StankyGtr 07
Jz Pno Bmin7	SB Gtr Fx 06	StankyGtr 08
Jz Pno DMaj	SB Gtr Fx 07	StankyGtr 09
Jz Pno DMaj7	SB Gtr Fx 08	StankyGtr 10
Jz Pno EbMj7	SB Gtr Fx 09	StankyGtr 11
Jz Pno Emin7	SB Gtr Fx 10	StankyGtr 12
Punk Gtr 01	SB Gtr Fx 11	StankyGtr 13
Punk Gtr 02	SB Gtr Fx 12	StankyHrms 1
Punk Gtr 03	SB Gtr Fx 13	StankyHrms 2
Punk Gtr 04	SB Gtr Fx 14	StankyHrms 3
Punk Gtr 05	SB Gtr Fx 15	StankySyn 1
Punk Gtr 06	SB Gtr Fx 16	StankySyn 2
Punk Gtr 07	SB Gtr Fx 17	StankySyn 3
Punk Gtr 08	SB Gtr Fx 18	StankySyn 4
Punk Gtr 09	SB Gtr Fx 19	StankySyn 5
Punk Gtr 10	SB Gtr Fx 20	StankySyn 6
R&G Sfx 1	SM Gtr 01	UrbnGtr Bb2
R&G Sfx 2	SM Gtr 02	UrbnGtr C3
R&G Sfx 3	SM Gtr 03	UrbnGtr Cmi7
R&G Sfx 4	SM Gtr 04	UrbnGtr D3
R&G Sfx 5	SM Gtr 05	UrbnGtr Eb3
R&G Sfx 6	SM Gtr 06	UrbnGtr G2
R&G Sfx 7	SM Gtr 07	UrbnGtr G3
R&G Sfx 8	SM Gtr 08	UrbnGtr Gmin
R&G Sfx 9	SM Gtr 09	UrbnSyn Cmin
R&G Syn 1	SM Gtr 10	UrbnSyn D
R&G Syn 2	SM Gtr 11	UrbnSyn Eb
R&G Syn 3	SM Gtr 12	UrbnSyn F
R&G Syn 4	SM Gtr 13	UrbnSyn Gmin
R&G Syn 5	SM Gtr 14	



THIS DEVICE COMPLIES WITH PART 15 OF THE FCC RULES. OPERATION IS SUBJECT TO THE FOLLOWING TWO CONDITIONS: (1) THIS DEVICE MAY NOT CAUSE HARMFUL INTERFERENCE, AND (2) THIS DEVICE MUST ACCEPT ANY INTERFERENCE RECEIVED, INCLUDING INTERFERENCE THAT MAY CAUSE UNDESIRED OPERATION.

www.alesis.com